

SANYO	No.779C	<h1 style="margin: 0;">2SA1209/2SC2911</h1> <p style="margin: 0;">PNP/NPN Epitaxial Planar Silicon Transistors</p> <p style="margin: 0;">160V/140mA High-Voltage Switching and AF 100W Predriver Applications</p>
--------------	---------	---

Features

- Adoption of FBET process
- High breakdown voltage
- Good linearity of h_{FE} and small C_{ob}
- Fast switching speed

() : 2SA1209

Maximum Ratings/ $T_a = 25^\circ\text{C}$

			unit
Collector-to-base voltage	V_{CBO}	(-)180	V
Collector-to-emitter voltage	V_{CEO}	(-)160	V
Emitter-to-base voltage	V_{EBO}	(-)5	V
Collector current	I_C	(-)140	mA
Collector Current (Pulse)	I_{CP}	(-)200	mA
Collector dissipation	P_C	1	W
		$T_c = 25^\circ\text{C}$	10
Junction temperature	T_j		150
Storage temperature	T_{stg}		-55 ~ +150

Electrical Characteristics/ $T_a = 25^\circ\text{C}$

			min	typ	max	unit
Collector cutoff current	I_{CBO}	$V_{CB} = (-)80, I_E = 0$			(-)0.1	μA
Emitter cutoff current	I_{EBO}	$V_{EB} = (-)4\text{ V}, I_C = 0$			(-)0.1	μA
Common emitter DC current gain	h_{FE}	$V_{CE} = (-)5\text{ V}, I_C = (-)10\text{ mA}$	100*		400*	
Gain-band width product	f_T	$V_{CE} = (-)10\text{ V}, I_C = (-)10\text{ mA}$		150		MHz
Common base output capacitance	C_{ob}	$V_{CB} = (-)10\text{ V}, f = 1\text{ MHz}$		(4.0)		pF
				3.0		
Collector to emitter saturation voltage	$V_{CE(sat)}$	$I_C = (-)50\text{ mA}, I_B = (-)5\text{ mA}$	(-0.14)	(-0.4)		V
			0.07	0.3		
Turn-on time	T_{on}	See specified test circuit.		0.1		μs
Storage time	t_{stg}	See specified test circuit.		1.5		μs
Fall time	t_f	See specified test circuit.		0.1		μs

*: The 2SA1209/2SC2911 are classified by 10 mA h_{FE} as follows:

100 R 200	140 S 280	200 T 400
-----------	-----------	-----------

Switching Time Test Circuit

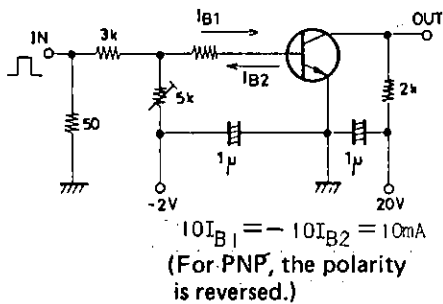

Unit (resistance: Ω , capacitance: F)

Package Dimensions 2009A

(unit: mm)

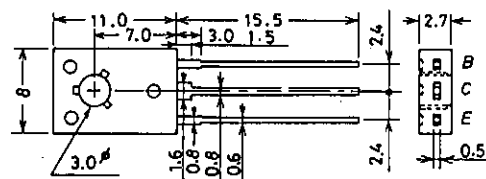

JEDEC: TO-126

B: Base
C: Collector
E: Emitter

2SA1209/2SC2911

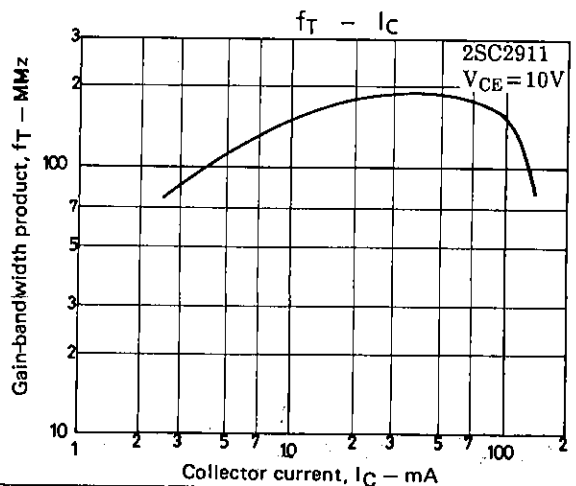
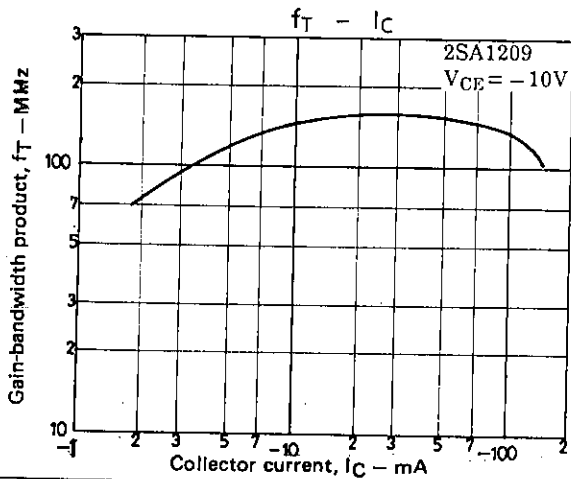
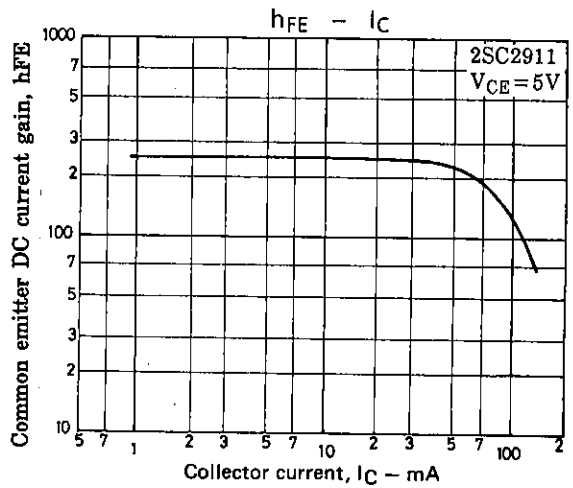
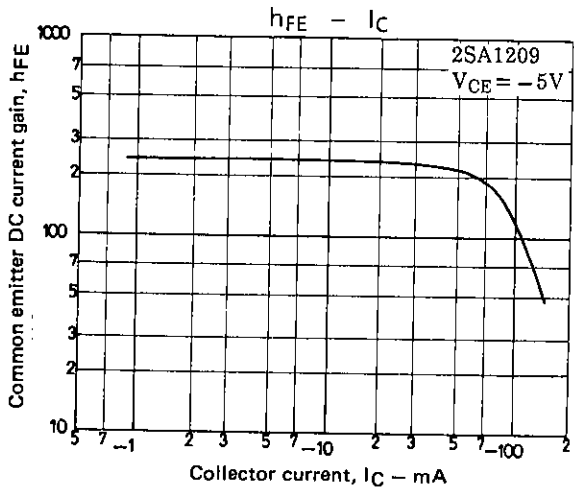
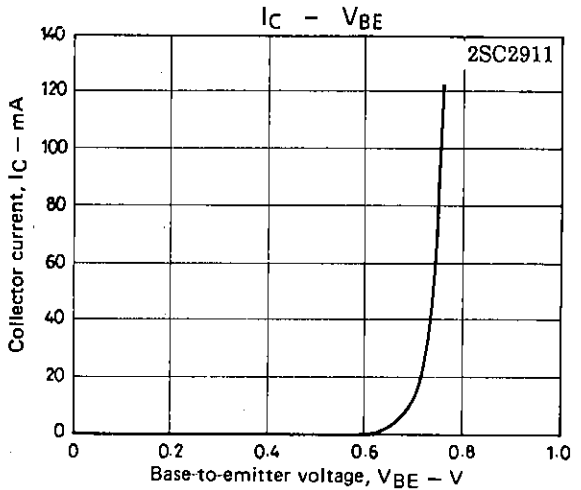
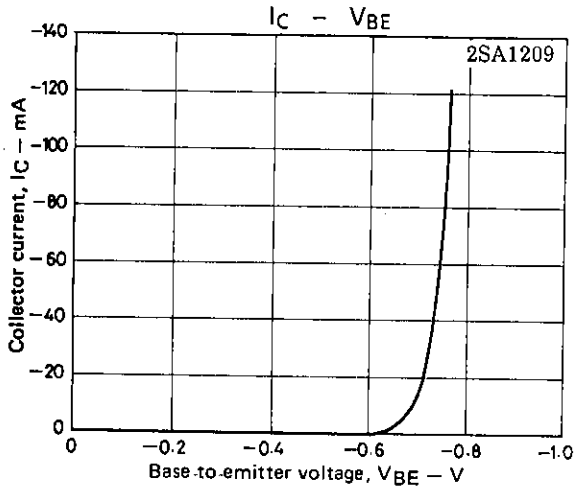
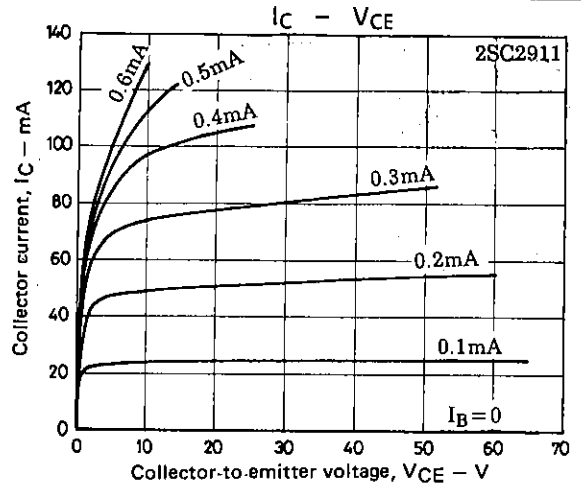
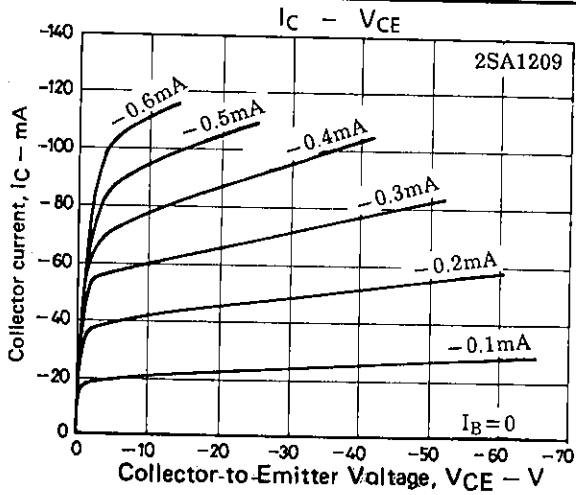

2SA1209/2SC2911

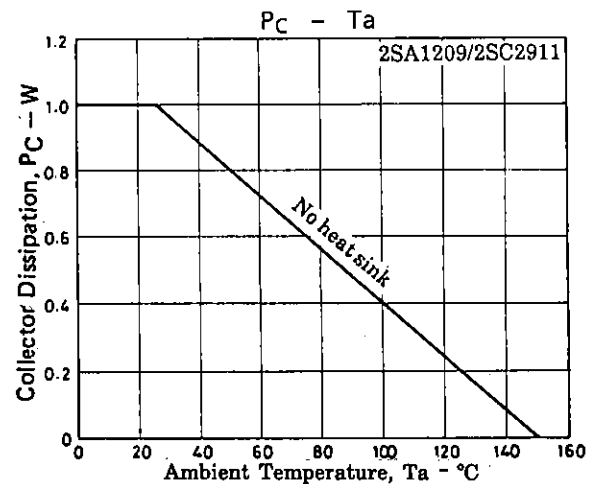
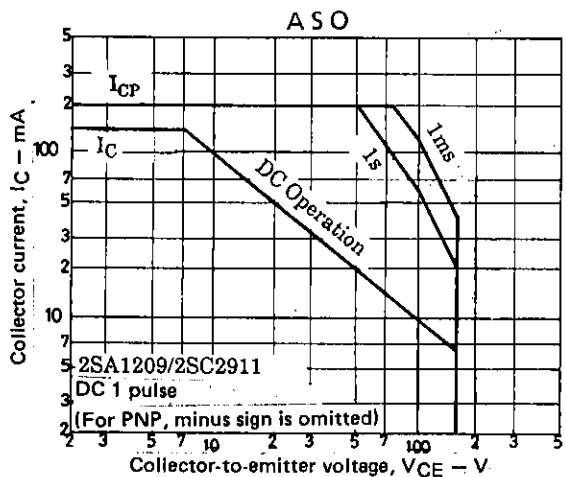
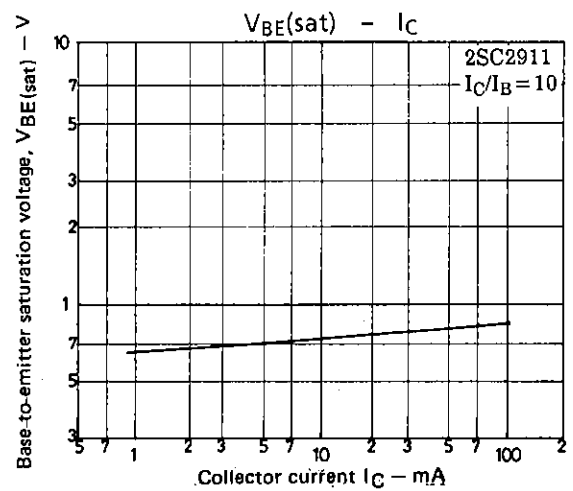
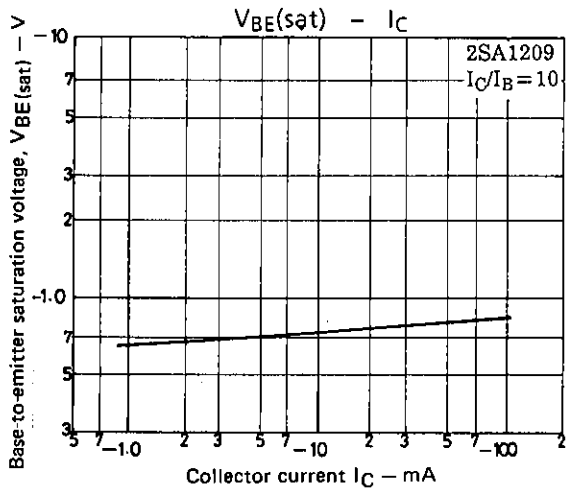
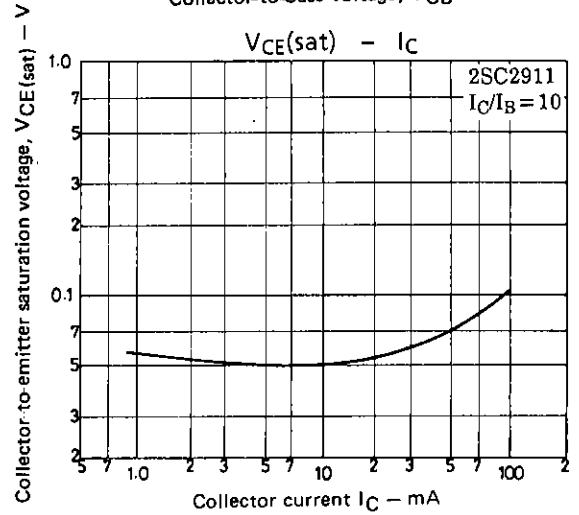
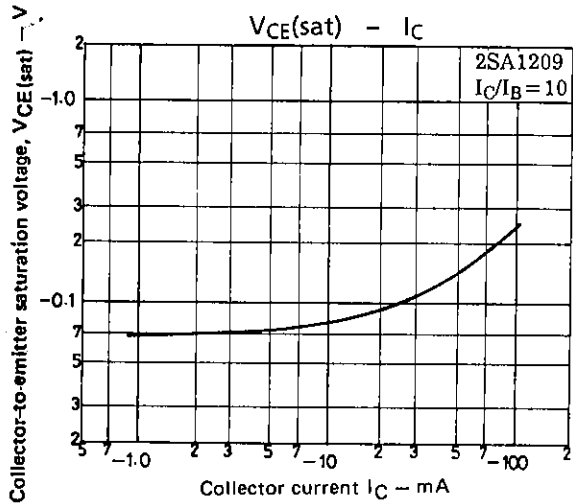
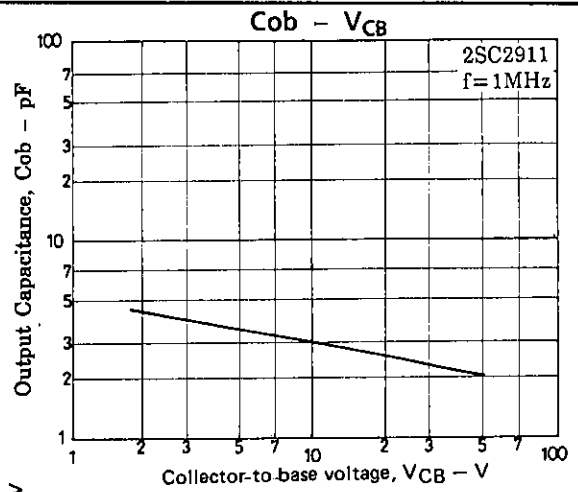
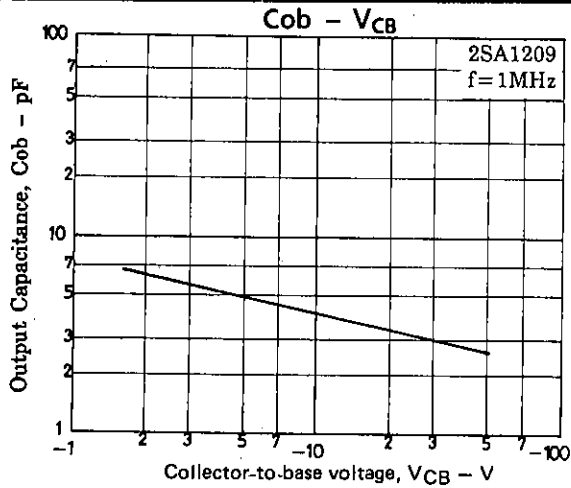

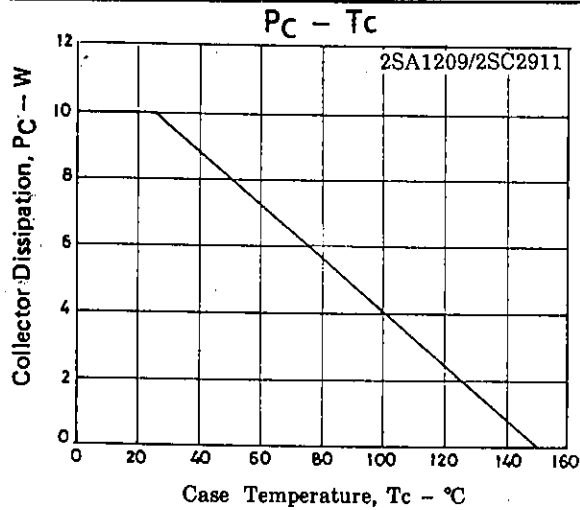

- No products described or contained herein are intended for use in surgical implants, life-support systems, aerospace equipment, nuclear power control systems, vehicles, disaster/crime-prevention equipment and the like, the failure of which may directly or indirectly cause injury, death or property loss.
- Anyone purchasing any products described or contained herein for an above-mentioned use shall:
 - ① Accept full responsibility and indemnify and defend SANYO ELECTRIC CO., LTD., its affiliates, subsidiaries and distributors and all their officers and employees, jointly and severally, against any and all claims and litigation and all damages, cost and expenses associated with such use:
 - ② Not impose any responsibility for any fault or negligence which may be cited in any such claim or litigation on SANYO ELECTRIC CO., LTD., its affiliates, subsidiaries and distributors or any of their officers and employees jointly or severally.
- Information (including circuit diagrams and circuit parameters) herein is for example only; it is not guaranteed for volume production. SANYO believes information herein is accurate and reliable, but no guarantees are made or implied regarding its use or any infringements of intellectual property rights or other rights of third parties.