

DISCRIPTION

2SC3019 is silicon NPN epitaxial planar type transistor designed for RF power amplifiers in UHF band.

FEATURES

- High power gain: $G_{pe} \geq 14\text{dB}$
@ $P_O = 0.5\text{W}$, $f = 520\text{MHz}$, $V_{CC} = 12.5\text{V}$
- Emitter ballasted construction for high reliability and good performance
- Small-disc-mold type package
- Collector dissipation: $P_C = 0.6\text{W}$, (@ $T_a = 25^\circ\text{C}$)
- Input/Output impedance:
 $Z_{in} = 2.6 - j3.0\Omega$, $Z_{out} = 16.5 - j56\Omega$
@ $f = 520\text{MHz}$, $V_{CC} = 12.5\text{V}$, $P_O = 0.5\text{W}$

APPLICATION

Exciter stage in UHF band mobile radio application

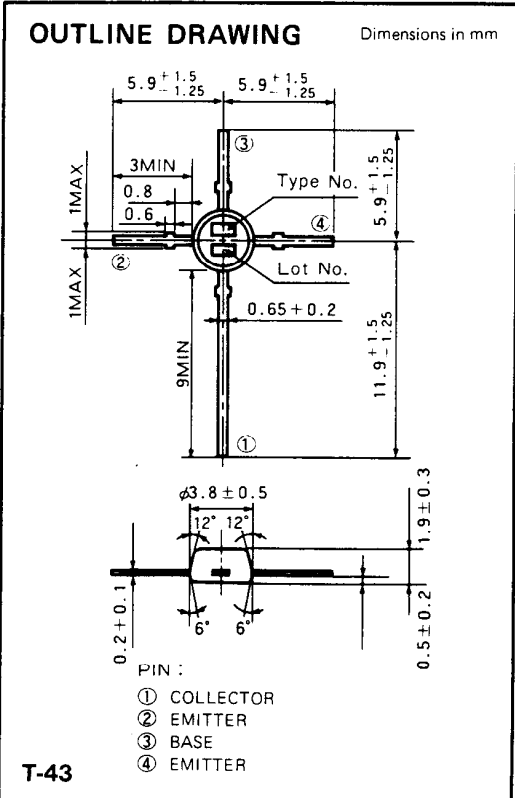

ABSOLUTE MAXIMUM RATINGS ($T_C = 25^\circ\text{C}$ unless otherwise specified)

Symbol	Parameter	Conditions	Ratings	Unit
V_{CBO}	Collector to base voltage		35	V
V_{EBO}	Emitter to base voltage		4	V
V_{CEO}	Collector to emitter voltage	$R_{BE} = \infty$	17	V
I_C	Collector current		0.4	A
P_C	Collector dissipation	$T_a = 25^\circ\text{C}$	0.6	W
		$T_C = 25^\circ\text{C}$	0.9	W
T_j	Junction temperature		135	$^\circ\text{C}$
T_{stg}	Storage temperature		-55 to 135	$^\circ\text{C}$
R_{th-a}	Thermal resistance	Junction to ambient	250	$^\circ\text{C/W}$
R_{th-c}		Junction to case	166	$^\circ\text{C/W}$

Note. Above parameters are guaranteed independently.

ELECTRICAL CHARACTERISTICS ($T_C = 25^\circ\text{C}$ unless otherwise specified)

Symbol	Parameter	Test conditions	Limits			Unit
			Min	Typ	Max	
$V_{(BR)EBO}$	Emitter to base breakdown voltage	$I_E = 1\text{mA}$, $I_C = 0$	4.0			V
$V_{(BR)CBO}$	Collector to base breakdown voltage	$I_C = 1\text{mA}$, $I_E = 0$	35			V
$V_{(BR)CEO}$	Collector to emitter breakdown voltage	$I_C = 10\text{mA}$, $R_{BE} = \infty$	17			V
I_{CBO}	Collector cutoff current	$V_{CB} = 15\text{V}$, $I_E = 0$			500	μA
I_{EBO}	Emitter cutoff current	$V_{EB} = 3\text{V}$, $I_C = 0$			500	μA
h_{FE}	DC forward current gain*	$V_{CE} = 10\text{V}$, $I_C = 50\text{mA}$	20	70	180	—
P_O	Output power	$V_{CC} = 12.5\text{V}$, $f = 520\text{MHz}$, $P_{in} = 20\text{mW}$	500	600		mW
η_C	Collector efficiency		40	50		%

Note. * Pulse test, $P_W = 150\mu\text{s}$, duty = 5%.

Above parameters, ratings, limits and conditions are subject to change.

TEST CIRCUIT

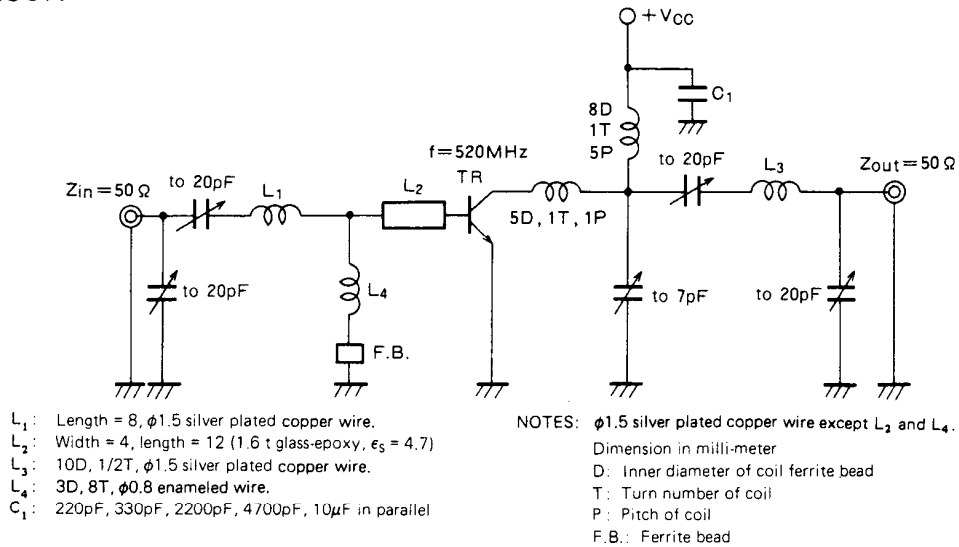

TYPICAL PERFORMANCE DATE

COLLECTOR DISSIPATION VS. AMBIENT TEMPERATURE

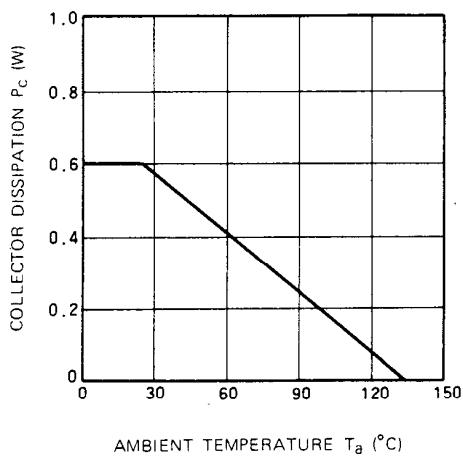

DC CURRENT GAIN VS. COLLECTOR CURRENT

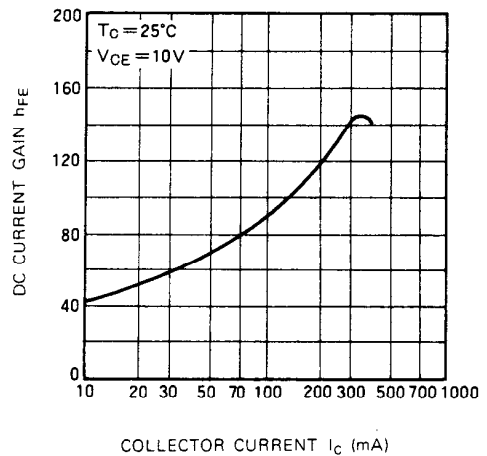

COLLECTOR OUTPUT CAPACITANCE VS. COLLECTOR TO BASE VOLTAGE

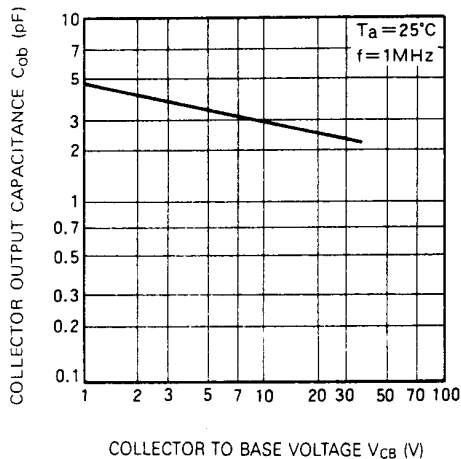

OUTPUT POWER, COLLECTOR EFFICIENCY VS. INPUT POWER

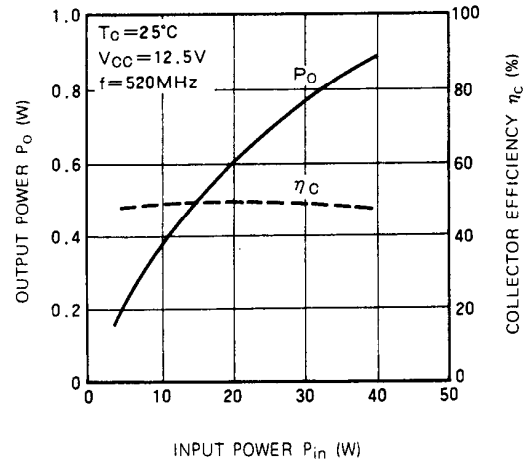

OUTPUT POWER VS. COLLECTOR SUPPLY VOLTAGE CHARACTERISTICS

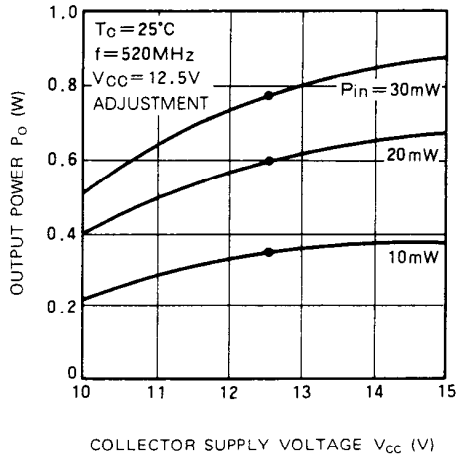

INPUT/OUTPUT IMPEDANCE

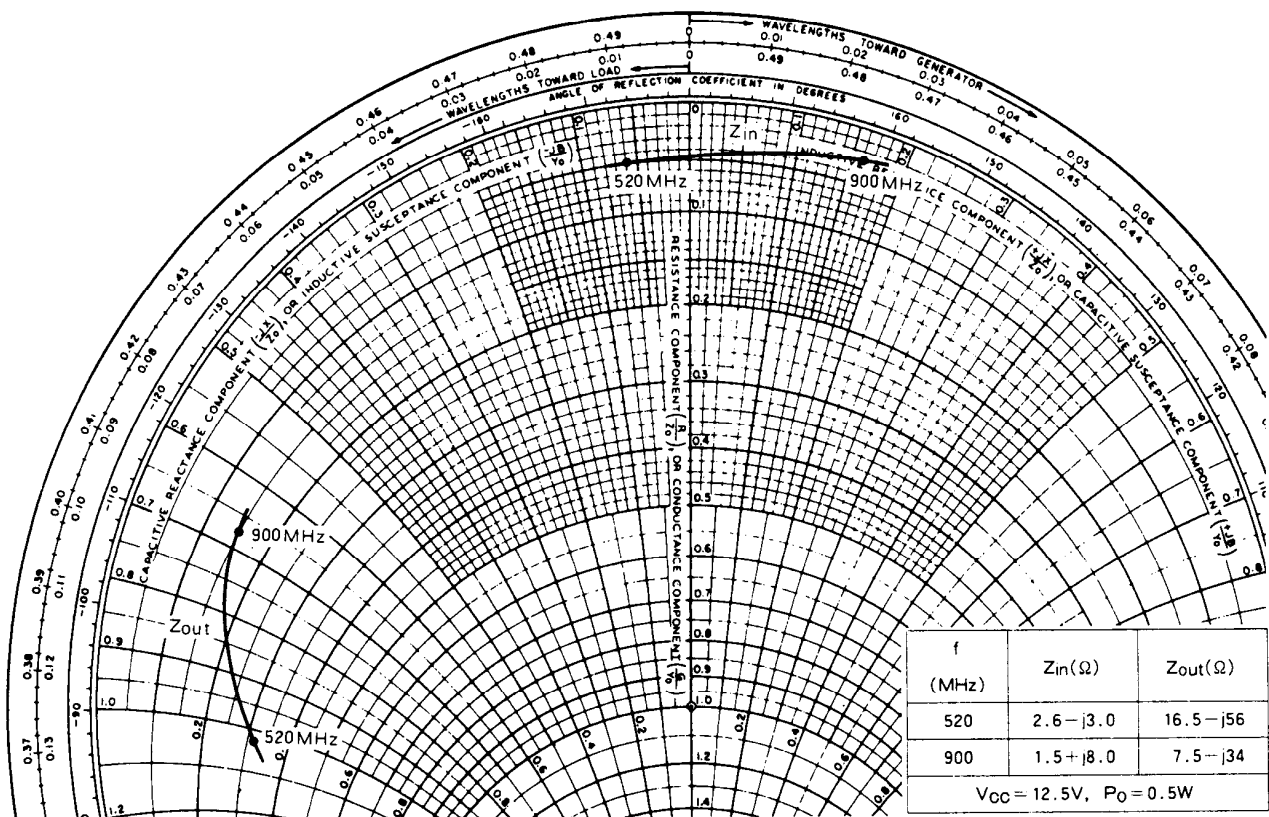

REFERENCE DATA (f = 900MHz)

OUTPUT POWER, COLLECTOR EFFICIENCY VS. INPUT POWER

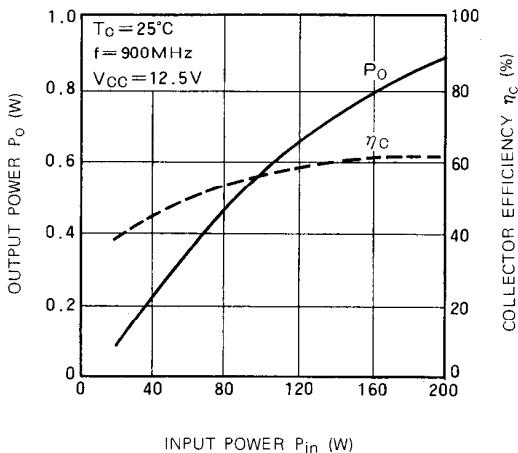

OUTPUT POWER VS. COLLECTOR SUPPLY VOLTAGE

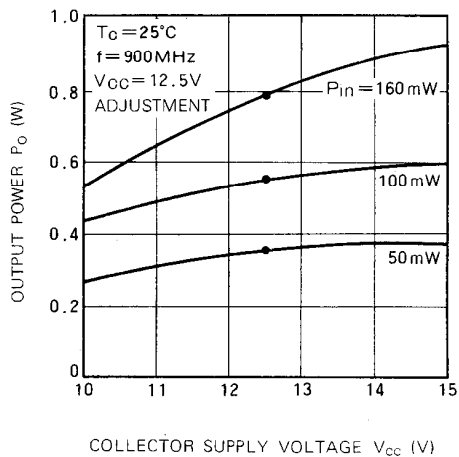

TEST CIRCUIT

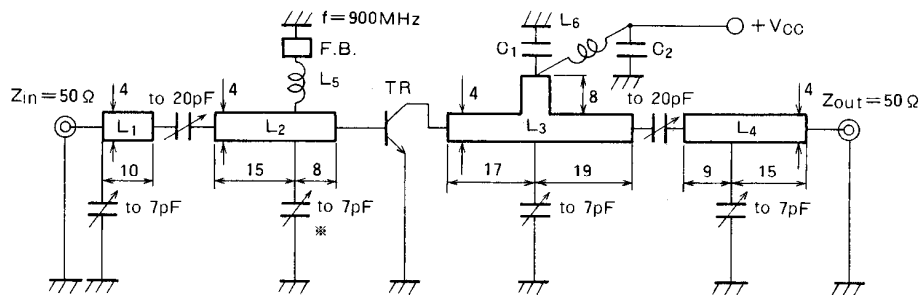

- L_1 to L_4 : Strip-line: 1.6 t glass-teflon $\epsilon_r = 2.7$
 - L_5 : 4D, 6T, AWG #20 enameled wire ($\phi 0.8\text{ mm}$)
 - L_6 : 4D, 5T, AWG #20 enameled wire ($\phi 0.8\text{ mm}$)
 - F.B.: Ferrite bead
 - C_1 : 1000pF in parallel
 - C_2 : 100pF, 56pF, 560pF, 4.7 μF in parallel
- Unit: mm

MATCHING PATTERN

