

# MITSUBISHI RF POWER TRANSISTOR 2SC3022

## NPN EPITAXIAL PLANAR TYPE

### DESCRIPTION

2SC3022 is a silicon NPN epitaxial planar type transistor specifically designed for UHF high power amplifier applications.

### FEATURES

- High Power Gain:  $G_{pe} \geq 4.7\text{dB}$   
@  $V_{CC} = 12.5\text{V}$ ,  $f = 520\text{MHz}$ ,  $P_{in} = 6\text{W}$ .
- Emitter ballasted construction.
- High ruggedness: Ability to withstand more than 20:1 load VSWR when operated at  $V_{CC} = 15.2\text{V}$ ,  $f = 520\text{MHz}$ ,  $P_O = 18\text{W}$ .
- Frange type ceramic package.
- $Z_{in} = 1.5 + j2.0\Omega$ ,  $Z_{out} = 2.8 + j1.0\Omega$ .  
@  $V_{CC} = 12.5\text{V}$ ,  $f = 520\text{MHz}$ ,  $P_O = 18\text{W}$ .

### APPLICATION

For output stage of 15W power amplifiers in UHF band.

### OUTLINE DRAWING

Dimensions in mm

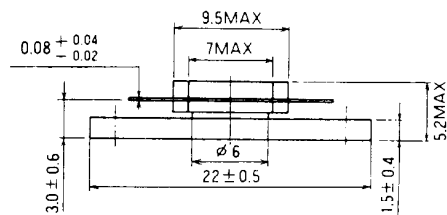
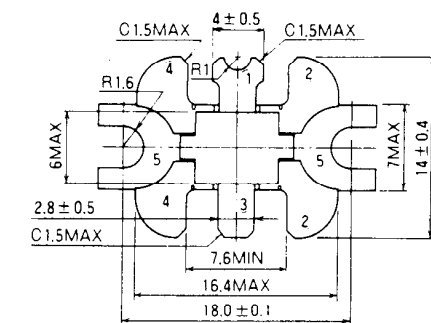

PIN :

- ① COLLECTOR
- ② EMITTER (FLANGE)
- ③ BASE
- ④ EMITTER (FLANGE)
- ⑤ FIN (EMITTER)

T-31E

### ABSOLUTE MAXIMUM RATINGS ( $T_C = 25^\circ\text{C}$ )

Symbol	Parameter	Conditions	Ratings	Unit
$V_{CBO}$	Collector to base voltage		35	V
$V_{EBO}$	Emitter to base voltage		4	V
$V_{CEO}$	Collector to emitter voltage	$R_{BE} = \infty$	17	V
$I_C$	Collector current		7	A
$P_C$	Collector dissipation	$T_C = 25^\circ\text{C}$	50	W
$T_j$	Junction temperature		175	$^\circ\text{C}$
$T_{stg}$	Storage temperature		-55 to 175	$^\circ\text{C}$
$R_{th-a}$	Thermal resistance	Junction to ambient	50	$^\circ\text{C}/\text{W}$
$R_{th-c}$		Junction to case	3	$^\circ\text{C}/\text{W}$

Note. Above parameters are guaranteed independently.

### ELECTRICAL CHARACTERISTICS ( $T_C = 25^\circ\text{C}$ )

Symbol	Parameter	Test conditions	Limits			Unit
			Min	Typ	Max	
$V_{(BR)EBO}$	Emitter to base breakdown voltage	$I_E = 10\text{mA}$ , $I_C = 0$	4			V
$V_{(BR)CBO}$	Collector to base breakdown voltage	$I_C = 10\text{mA}$ , $I_E = 0$	35			V
$V_{(BR)CEO}$	Collector to emitter breakdown voltage	$I_C = 0.1\text{A}$ , $R_{BE} = \infty$	17			V
$I_{CBO}$	Collector cut off current	$V_{CB} = 15\text{V}$ , $I_E = 0$			2.0	mA
$I_{EBO}$	Emitter cut off current	$V_{EB} = 3\text{V}$ , $I_C = 0$			3.0	mA
$h_{FE}$	DC forward current gain*	$V_{CE} = 10\text{V}$ , $I_C = 1\text{A}$	20	50	180	-
$P_O$	Power Output	$V_{CC} = 12.5\text{V}$ , $P_{in} = 6\text{W}$ , $f = 520\text{MHz}$	18	19		W
$\eta_C$	Collector efficiency		55	60		%

Note. \* Pulse test,  $P_w = 150\mu\text{s}$ , duty = 5%.

Above parameters, ratings, limits and conditions are subject to change.

**NPN EPITAXIAL PLANAR TYPE**

**TEST CIRCUIT (f = 520MHz)**

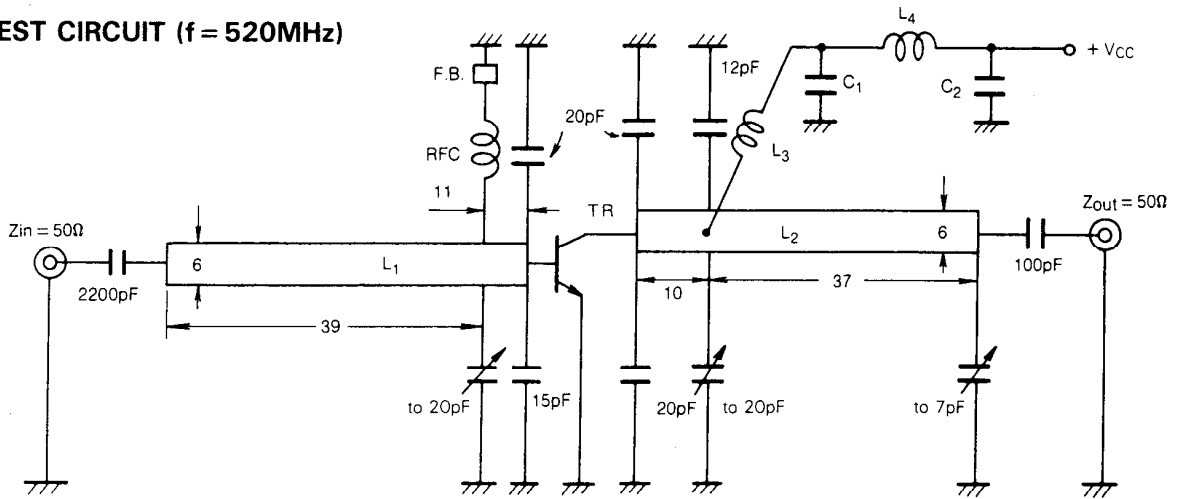

L<sub>1</sub>, L<sub>2</sub>: Microstrip Board Material 1.6mm Thick glass-teflon  $\epsilon_r = 2.7$   
 L<sub>3</sub>: 3 Turns AWG #20, 8mm I.D.  
 L<sub>4</sub>: 6 Turns AWG #20, 8mm I.D.  
 RFC: 8 Turns AWG #26 Enameled Wire on 4mm O.D., 14mm Length Bakelite.

F.B.: Ferrite Bead  
 C<sub>1</sub>: 68pF, 3300pF, 4700pF, 33 $\mu$ F in parallel  
 C<sub>2</sub>: 3300pF, 4700pF, 33 $\mu$ F in parallel

**TYPICAL PERFORMANCE DATA**

**COLLECTOR DISSIPATION VS. CASE TEMPERATURE CHARACTERISTICS**

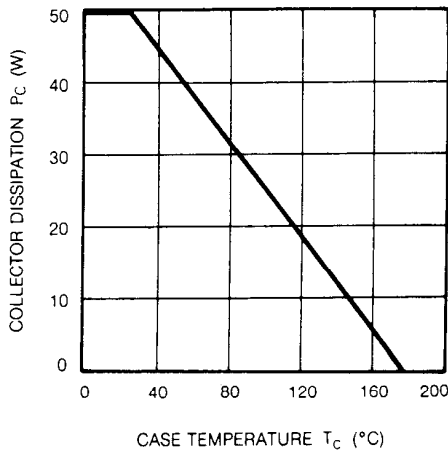

**COLLECTOR CURRENT VS. COLLECTOR TO EMITTER VOLTAGE**

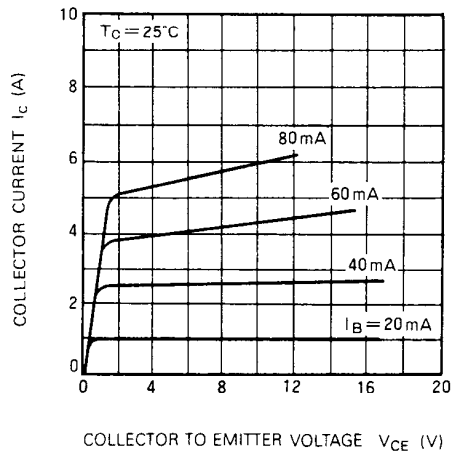

**COLLECTOR TO EMITTER BREAKDOWN VOLTAGE VS. BASE TO EMITTER RESISTANCE**

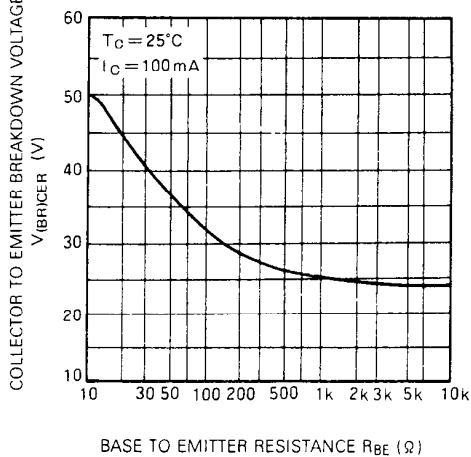

**COLLECTOR OUTPUT CAPACITANCE VS. COLLECTOR TO BASE VOLTAGE CHARACTERISTICS**

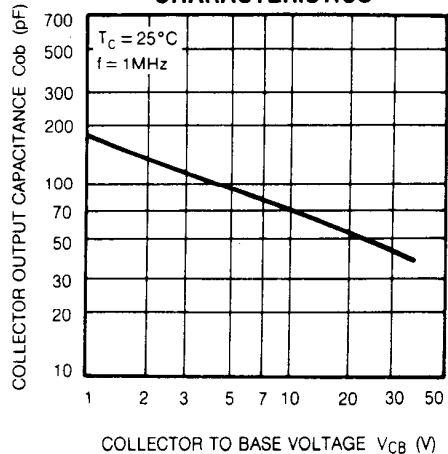

**OUTPUT POWER, COLLECTOR EFFICIENCY VS. INPUT POWER CHARACTERISTICS**

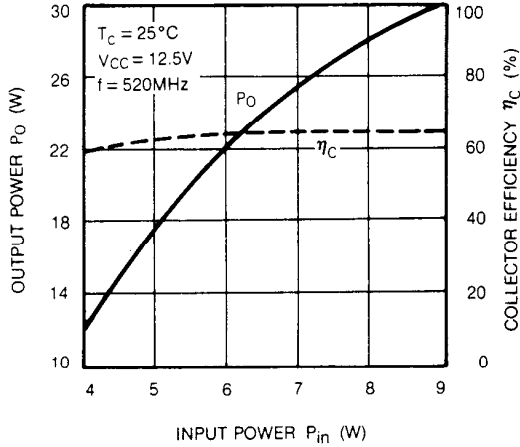

**OUTPUT POWER VS. COLLECTOR SUPPLY VOLTAGE CHARACTERISTICS**

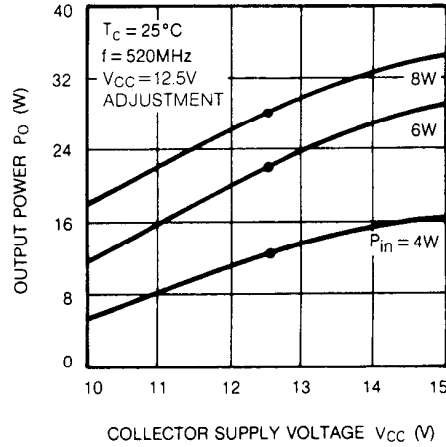

**OUTPUT POWER VS. FREQUENCY CHARACTERISTICS**

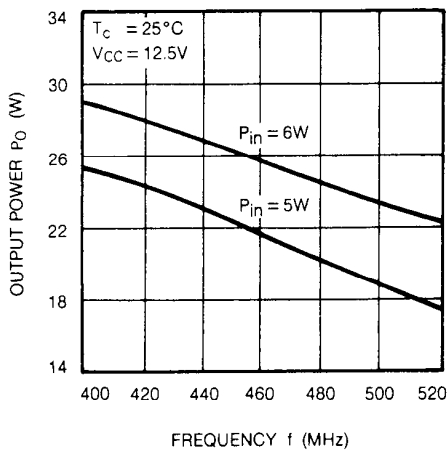

**SERIES INPUT AND OUTPUT IMPEDANCE VS. FREQUENCY CHARACTERISTICS**

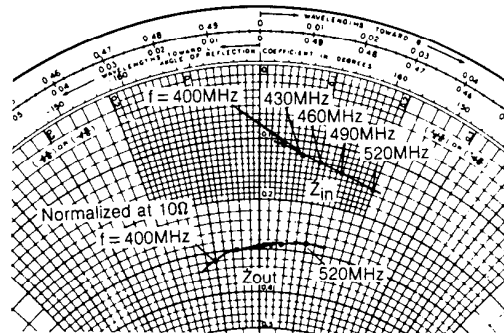

f(MHz)	$Z_{in}(\Omega)$	$Z_{out}(\Omega)$
400	$1.10 + j0.5$	$3.2 - j1.0$
430	$1.15 + j0.75$	$3.0 - j0.5$
460	$1.25 + j1.0$	$2.95 \pm j0.0$
490	$1.35 + j1.4$	$2.9 + j0.5$
520	$1.50 + j2.0$	$2.8 + j1.0$

Conditions:  
 $T_c = 25^\circ\text{C}$ ,  $V_{CC} = 12.5\text{V}$ ,  $P_o = 18\text{W}$

**PRECAUTIONS FOR MOUNTING HIGH-FREQUENCY HIGH-OUTPUT TRANSISTOR FOR MOBILE RADIO EQUIPMENT**

When mounting high-frequency, high-output transistors for mobile radio equipment (flange screw fastening part cut package), care should be taken to the following points.

1. When mounting the device to the heat sink, silicon compound should be applied to the heat sink and device heat radiating fin and apply the device to the heat sink using a proper fastening tool.
2. If the device is soldered directly to heat sink, excessive thermal stress will result in deteriorating the reliability. Do not use this mounting method.
3. Care should be taken, if the device is applied to the heat sink, the force of soldering the leads to the printed circuit board results in continual mechanical stress, deteriorating the reliability and performance of the system.
4. Refer to Mitsubishi's DATABOOK or manuals for transistors, small-signal diodes and integrated circuit modules for mounting and handling of the device.