

CD4073B, CD4081B, CD4082B Types

CMOS AND Gates

High-Voltage Types (20-Volt Rating)

CD4073B Triple 3-Input AND Gate
CD4081B Quad 2-Input AND Gate
CD4082B Dual 4-Input AND Gate

■ CD4073B, CD4081B and CD-4082B AND gates provide the system designer with direct implementation of the AND function and supplement the existing family of CMOS gates.

The CD4073B, CD4081B and CD4082B types are supplied in 14-lead dual-in-line ceramic packages (D and F suffixes), 14-lead dual-in-line plastic packages (E suffix), and in chip form (H suffix).

Features:

- Medium-Speed Operation — t_{PLH} , $t_{PHL} = 60$ ns (typ.) at $V_{DD} = 10$ V
- 100% tested for quiescent current at 20 V
- Maximum input current of $1 \mu A$ at 18 V over full package-temperature range; 100 nA at 18 V and 25°C
- Noise margin (full package-temperature range) =
 - 1 V at $V_{DD} = 5$ V
 - 2 V at $V_{DD} = 10$ V
 - 2.5 V at $V_{DD} = 15$ V
- Standardized, symmetrical output characteristics
- 5-V, 10-V, and 15-V parametric ratings
- Meets all requirements of JEDEC Tentative Standard No. 13B, "Standard Specifications for Description of 'B' Series CMOS Devices"

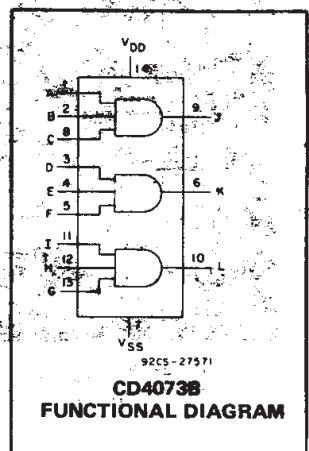
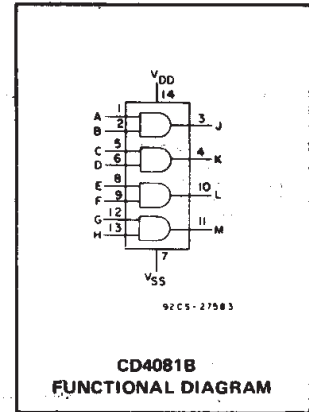

MAXIMUM RATINGS, Absolute-Maximum Values:

DC SUPPLY-VOLTAGE RANGE, (V_{DD})	-0.5V to +20V	
Voltages referenced to V_{SS} Terminal		
INPUT VOLTAGE RANGE, ALL INPUTS	-0.5V to $V_{DD} + 0.5V$	
DC INPUT CURRENT, ANY ONE INPUT	± 10 mA	
POWER DISSIPATION PER PACKAGE (P_D):		
For $T_A = -55^\circ C$ to $+100^\circ C$	500mW	
For $T_A = +100^\circ C$ to $+125^\circ C$	Derate Linearly at 12mW/ $^\circ C$ to 200mW	
DEVICE DISSIPATION PER OUTPUT TRANSISTOR		
FOR $T_A =$ FULL PACKAGE-TEMPERATURE RANGE (All Package Types)	100mW	
OPERATING-TEMPERATURE RANGE (T_A)	$-55^\circ C$ to $+125^\circ C$	
STORAGE TEMPERATURE RANGE (T_{stg})	$-65^\circ C$ to $+150^\circ C$	
LEAD TEMPERATURE (DURING SOLDERING):		
At distance 1/16 \pm 1/32 inch (1.59 \pm 0.79mm) from case for 10s max	$+265^\circ C$	

RECOMMENDED OPERATING CONDITIONS

For maximum reliability, nominal operating conditions should be selected so that operation is always within the following ranges:

CHARACTERISTIC	LIMITS		UNITS
	MIN.	MAX.	
Supply-Voltage Range (For $T_A =$ Full Package Temperature Range)	3	18	V

DYNAMIC ELECTRICAL CHARACTERISTICS at $T_A = 25^\circ C$, Input $t_r, t_f = 20$ ns, and $C_L = 50$ pF, $R_L = 200$ k Ω

CHARACTERISTIC	TEST CONDITIONS	ALL TYPES LIMITS		UNITS	
		V_{DD} Volts	TYP.		MAX.
Propagation Delay Time, t_{PHL}, t_{PLH}		5	125	250	ns
		10	60	120	
		15	45	90	
Transition Time, t_{THL}, t_{TLH}		5	100	200	ns
		10	50	100	
		15	40	80	
Input Capacitance, C_{IN}	Any Input	—	5	7.5	pF

CD4073B, CD4081B, CD4082B Types

STATIC ELECTRICAL CHARACTERISTICS

CHARACTERISTIC	CONDITIONS			LIMITS AT INDICATED TEMPERATURES (°C)							UNITS
	V _O (V)	V _{IN} (V)	V _{DD} (V)					+25			
				-55	-40	+85	+125	Min.	Typ.	Max.	
Quiescent Device Current, I _{DD} Max.	—	0,5	5	0.25	0.25	7.5	7.5	—	0.01	0.25	μA
	—	0,10	10	0.5	0.5	15	15	—	0.01	0.5	
	—	0,15	15	1	1	30	30	—	0.01	1	
	—	0,20	20	5	5	150	150	—	0.02	5	
Output Low (Sink) Current, I _{OL} Min.	0.4	0,5	5	0.64	0.61	0.42	0.36	0.51	1	—	mA
	0.5	0,10	10	1.6	1.5	1.1	0.9	1.3	2.6	—	
	1.5	0,15	15	4.2	4	2.8	2.4	3.4	6.8	—	
Output High (Source) Current, I _{OH} Min.	4.6	0,5	5	-0.64	-0.61	-0.42	-0.36	-0.51	-1	—	mA
	2.5	0,5	5	-2	-1.8	-1.3	-1.15	-1.6	-3.2	—	
	9.5	0,10	10	-1.6	-1.5	-1.1	-0.9	-1.3	-2.6	—	
	13.5	0,15	15	-4.2	-4	-2.8	-2.4	-3.4	-6.8	—	
Output Voltage: Low-Level, V _{OL} Max.	—	0,5	5	0.05				—	0	0.05	V
	—	0,10	10	0.05				—	0	0.05	
	—	0,15	15	0.05				—	0	0.05	
Output Voltage: High-Level, V _{OH} Min.	—	0,5	5	4.95				4.95	5	—	V
	—	0,10	10	9.95				9.95	10	—	
	—	0,15	15	14.95				14.95	15	—	
Input Low Voltage, V _{IL} Max.	0.5	—	5	1.5				—	—	1.5	V
	1	—	10	3				—	—	3	
	1.5	—	15	4				—	—	4	
Input High Voltage, V _{IH} Min.	0.5, 4.5	—	5	3.5				3.5	—	—	V
	1, 9	—	10	7				7	—	—	
	1.5, 13.5	—	15	11				11	—	—	
Input Current I _{IN} Max.		0,18	18	±0.1	±0.1	±1	±1	—	±10 ⁻⁵	±0.1	μA

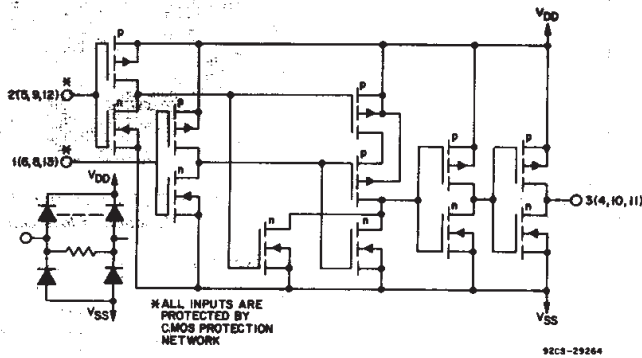

Fig. 1 - Schematic diagram for CD4081B (1 of 4 identical gates).

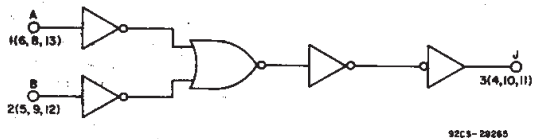

Fig. 2 - Logic diagram for CD4081B (1 of 4 identical gates).

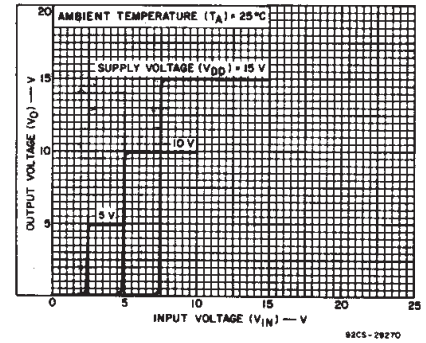

Fig. 3 - Typical voltage transfer characteristics.

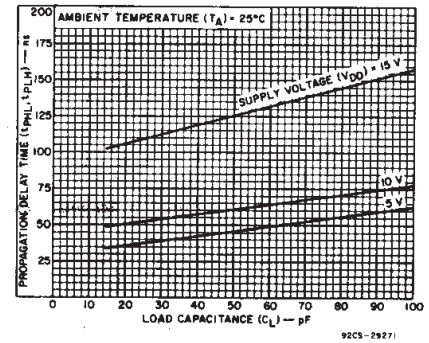

Fig. 4 - Typical propagation delay time as a function of load capacitance.

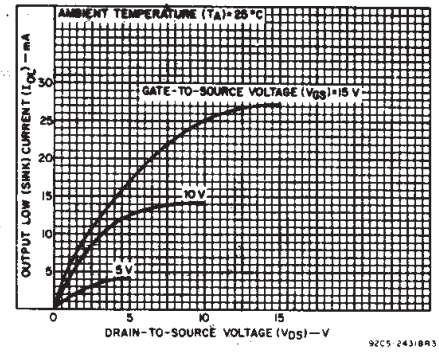

Fig. 5 - Typical output low (sink) current characteristics.

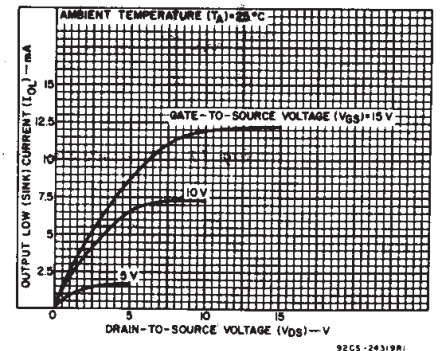

Fig. 6 - Minimum output low (sink) current characteristics.

3
COMMERCIAL CMOS
HIGH VOLTAGE ICs

CD4073B, CD4081B, CD4082B Types



Fig. 7 — Schematic diagram for CD4082B (1 of 2 identical gates).



Fig. 9 — Logic diagram for CD4082B (1 of 2 identical gates).

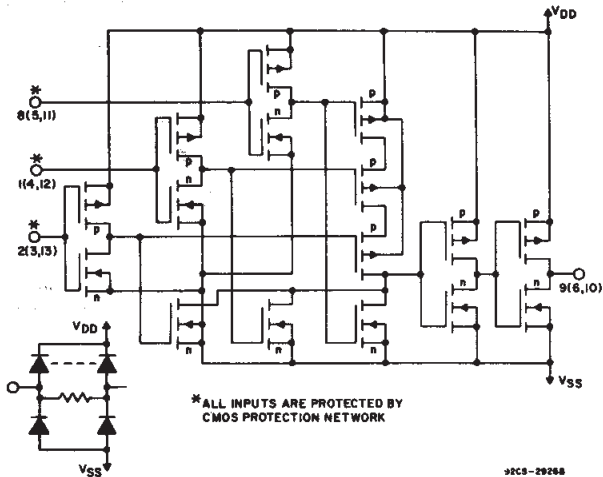

Fig. 11 — Schematic diagram for CD4073B (1 of 3 identical gates).

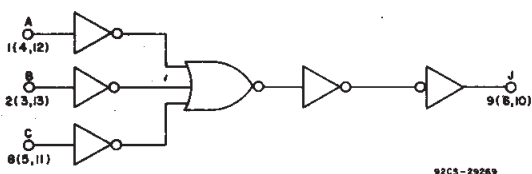

Fig. 13 — Logic diagram for CD4073B (1 of 3 identical gates).

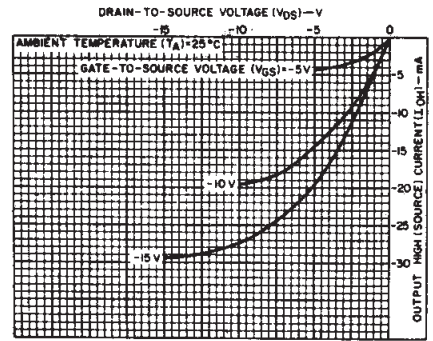

Fig. 8 — Typical output high (source) current characteristics.

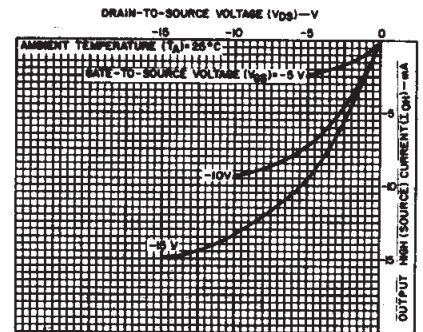

Fig. 10 — Minimum output high (source) current characteristics.

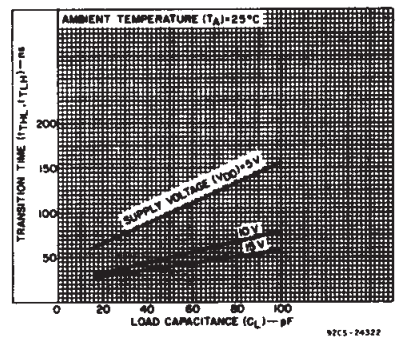

Fig. 12 — Typical transition time as a function of load capacitance



Fig. 14 — Typical dynamic power dissipation per gate as a function of frequency.

CD4073B, CD4081B, CD4082B Types



Fig. 15 - Quiescent device current test circuit.

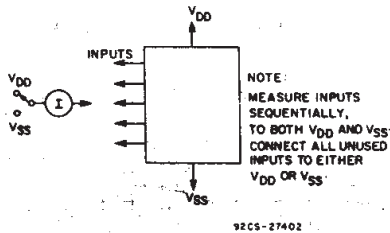

Fig. 16 - Input current test circuit.

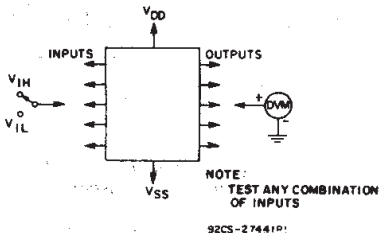
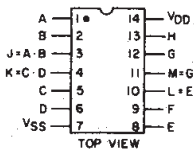
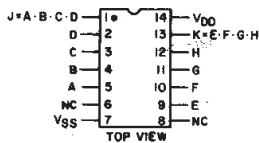

Fig. 17 - Input-voltage test circuit.

TERMINAL ASSIGNMENTS



CD4081B



CD4082B

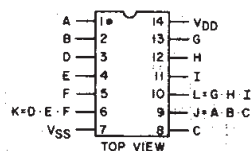

CD4073B

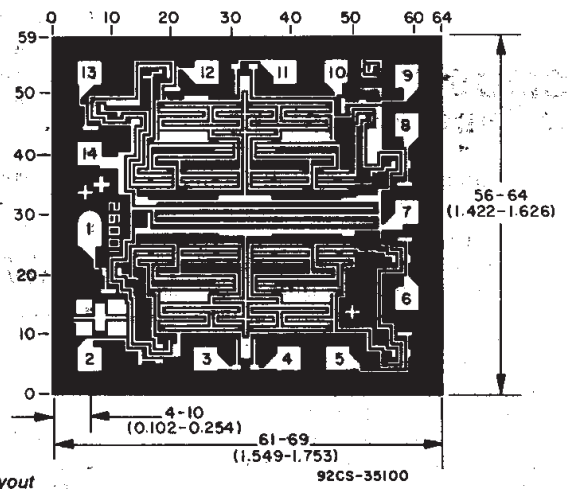

Chip dimensions and pad layout for CD4081B.

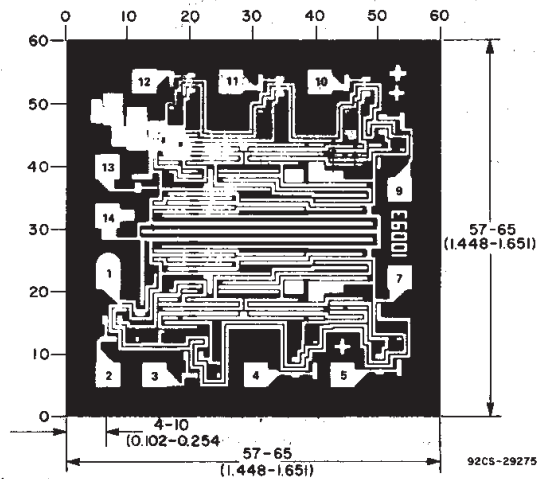

Chip dimensions and pad layout for CD4082B.

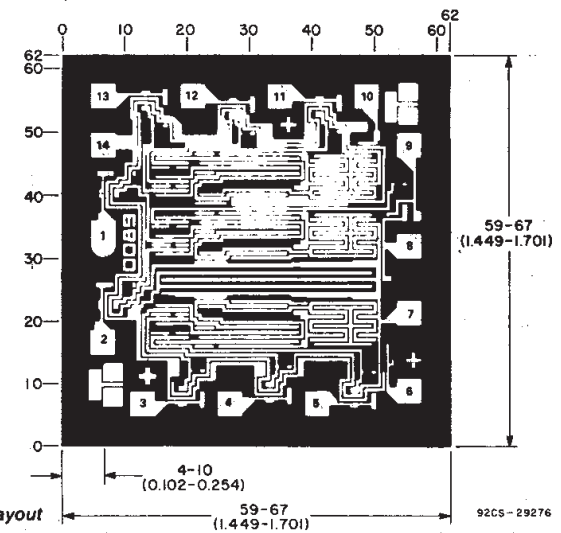

Chip dimensions and pad layout for CD4073B.

Dimensions in parentheses are in millimeters and are derived from the basic inch dimensions as indicated. Grid graduations are in mils (10^{-3} inch).

3
COMMERCIAL CMOS
HIGH VOLTAGE ICs

IMPORTANT NOTICE

Texas Instruments and its subsidiaries (TI) reserve the right to make changes to their products or to discontinue any product or service without notice, and advise customers to obtain the latest version of relevant information to verify, before placing orders, that information being relied on is current and complete. All products are sold subject to the terms and conditions of sale supplied at the time of order acknowledgement, including those pertaining to warranty, patent infringement, and limitation of liability.

TI warrants performance of its semiconductor products to the specifications applicable at the time of sale in accordance with TI's standard warranty. Testing and other quality control techniques are utilized to the extent TI deems necessary to support this warranty. Specific testing of all parameters of each device is not necessarily performed, except those mandated by government requirements.

CERTAIN APPLICATIONS USING SEMICONDUCTOR PRODUCTS MAY INVOLVE POTENTIAL RISKS OF DEATH, PERSONAL INJURY, OR SEVERE PROPERTY OR ENVIRONMENTAL DAMAGE ("CRITICAL APPLICATIONS"). TI SEMICONDUCTOR PRODUCTS ARE NOT DESIGNED, AUTHORIZED, OR WARRANTED TO BE SUITABLE FOR USE IN LIFE-SUPPORT DEVICES OR SYSTEMS OR OTHER CRITICAL APPLICATIONS. INCLUSION OF TI PRODUCTS IN SUCH APPLICATIONS IS UNDERSTOOD TO BE FULLY AT THE CUSTOMER'S RISK.

In order to minimize risks associated with the customer's applications, adequate design and operating safeguards must be provided by the customer to minimize inherent or procedural hazards.

TI assumes no liability for applications assistance or customer product design. TI does not warrant or represent that any license, either express or implied, is granted under any patent right, copyright, mask work right, or other intellectual property right of TI covering or relating to any combination, machine, or process in which such semiconductor products or services might be or are used. TI's publication of information regarding any third party's products or services does not constitute TI's approval, warranty or endorsement thereof.