

Package Style: Bare Die



Product Description

The FMA3058 is a high performance 2GHz to 20GHz Gallium Arsenide monolithic travelling wave amplifier. It is suitable for use in broadband communication, instrumentation, and electronic warfare applications. The die is fabricated using our 0.25µm process. The circuit is DC-blocked at both the RF input and the RF output.

Features

- 15 dB Gain
- Low Noise Amplifier
- Single Supply +5V @ 90mA
- 15dBm P1dB Output Power at 20GHz
- pHEMT Technology
- Input Return Loss < -12dB
- Output Return Loss < -10dB

Applications

- Test Instrumentation
- Electronic Warfare
- Broadband Communication Infrastructure
- Fiber Optics

Optimum Technology Matching® Applied

- GaAs HBT
- GaAs MESFET
- InGaP HBT
- SiGe BiCMOS
- Si BiCMOS
- SiGe HBT
- GaAs pHEMT
- Si CMOS
- Si BJT
- GaN HEMT
- InP HBT
- RF MEMS
- LDMOS

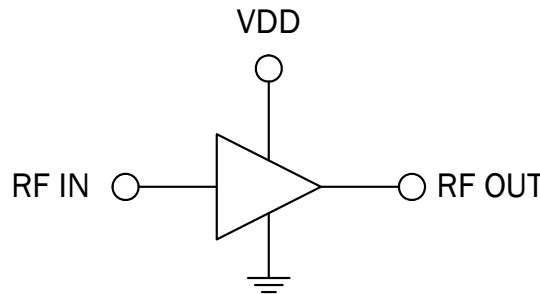

Parameter	Specification			Unit	Condition
	Min.	Typ.	Max.		
Electrical Specifications (Small-Signal Unless Noted)					$T_{AMBIENT} = 25\text{ }^{\circ}\text{C}$, $Z_0 = 50\Omega$ pads B and C open circuit.
Small Signal Gain	12	15	18	dB	2 GHz to 20 GHz
Input Return Loss		-12	-10	dB	2 GHz to 20 GHz
Output Return Loss		-12	-10	dB	2 GHz to 20 GHz
Output Power at P1dB Compression Point	15	17		dBm	2 GHz, 5V drain bias
	15	17		dBm	10 GHz, 5V drain bias
	12	15		dBm	20 GHz, 5V drain bias
Drain Current		90		mA	5V drain bias
Noise Figure		3.5		dB	2 GHz, 5V drain bias
		3		dB	10 GHz, 5V drain bias
		6.5		dB	20 GHz, 5V drain bias

Note: The device has a default current, set by an on-chip resistor. Pads B and C can be bonded to ground to increase the device current by reducing the default resistance.

Absolute Maximum Ratings

Parameter	Rating	Unit
Maximum Input Power (P_{IN})	+20	dBm
Drain Voltage (V_{DD})	+12	V
Total Power Dissipation (P_{TOT})		
Thermal Resistivity (θ_{JC})		
Operating Temperature (T_{OPER})	-55 to 85	°C
Storage Temperature (T_{STOR})	-55 to 150	°C



Caution! ESD sensitive device.

Exceeding any one or a combination of the Absolute Maximum Rating conditions may cause permanent damage to the device. Extended application of Absolute Maximum Rating conditions to the device may reduce device reliability. Specified typical performance or functional operation of the device under Absolute Maximum Rating conditions is not implied.

RoHS status based on EU Directive 2002/95/EC (at time of this document revision).

The information in this publication is believed to be accurate and reliable. However, no responsibility is assumed by RF Micro Devices, Inc. ("RFMD") for its use, nor for any infringement of patents, or other rights of third parties, resulting from its use. No license is granted by implication or otherwise under any patent or patent rights of RFMD. RFMD reserves the right to change component circuitry, recommended application circuitry and specifications at any time without prior notice.

Pad Layout

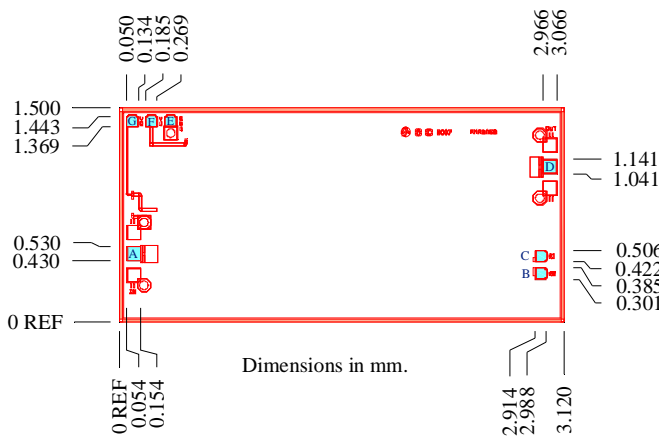

Pad	Name	Description
A	IN	RF input
B	R2	Internal source bias resistor
C	R1	Internal source bias resistor
D	OUT	RF output
E	GND	Ground
F	VD	Drain voltage
G	VG	Optional gate voltage

Die Size (μm)	Die Thickness (μm)	Min. Bond Pad Pitch (μm)	Min. Bond Pad Opening ($\mu\text{m} \times \mu\text{m}$)
3120x1500	100	122	72x62

Typical Measured Performance for On-Wafer Measurements

Measurement Conditions: $I_D=90\text{mA}$, $V_{DD}=5\text{V}$, $T_{\text{AMBIENT}}=25^\circ\text{C}$, pads B and C open circuit.

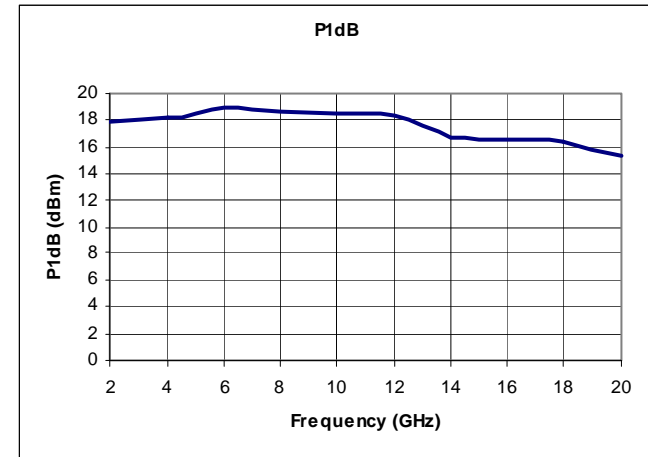
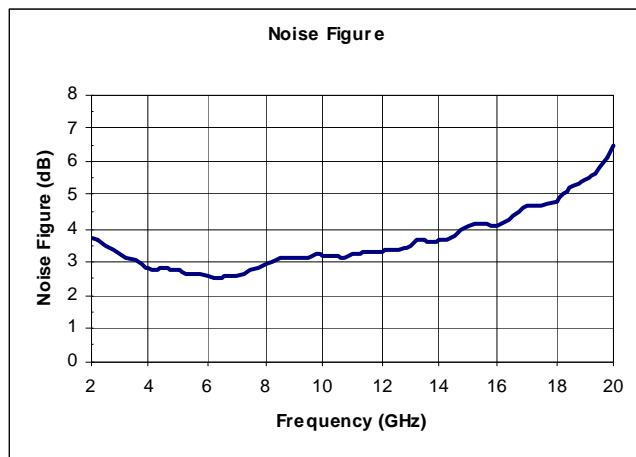
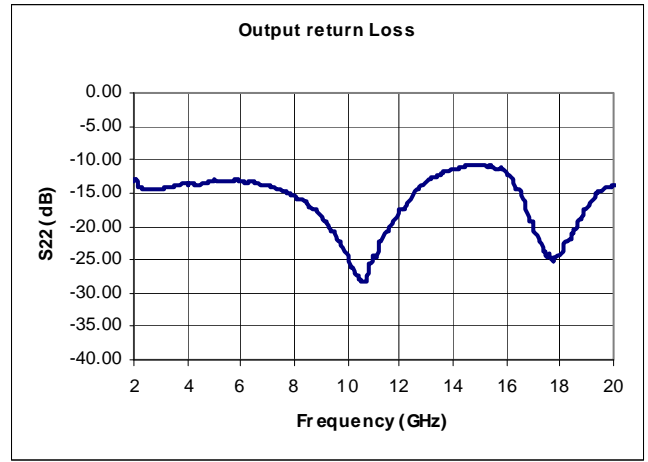
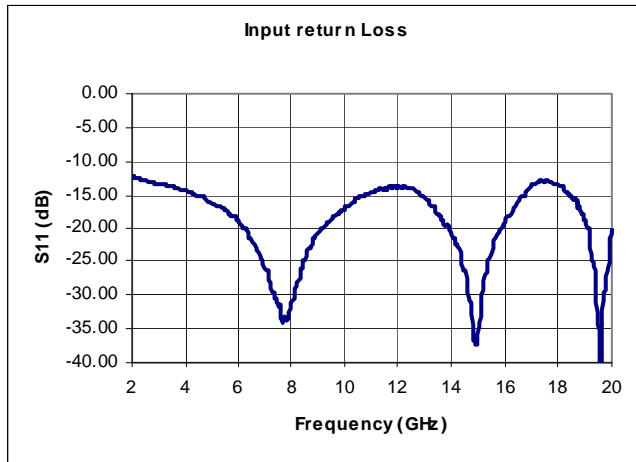
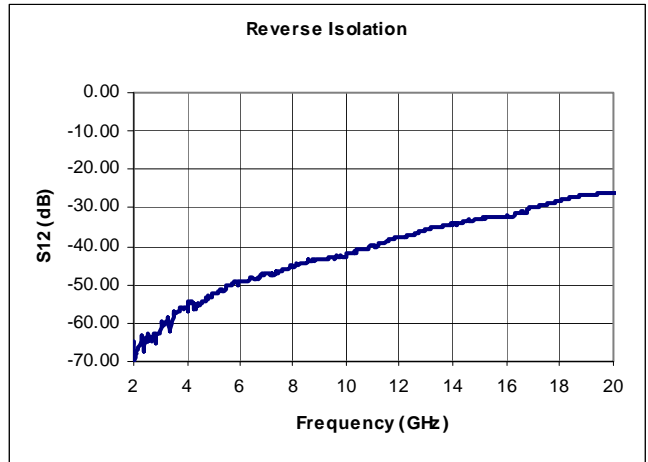
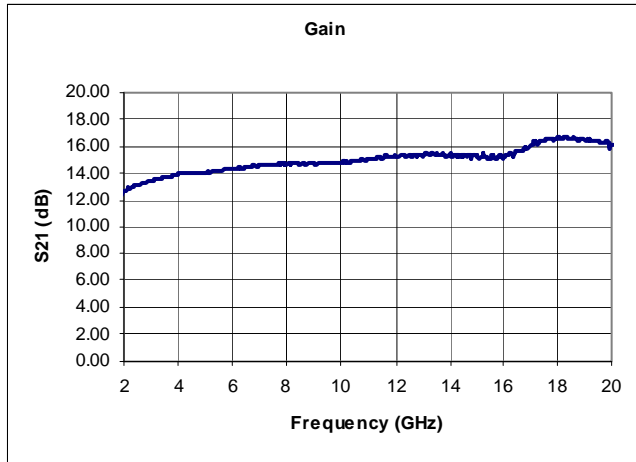

Typical Performance for On-Wafer Measurements Over Temperature

Measurement Conditions: $I_D = 90\text{ mA}$, $V_{DD} = 5\text{ V}$, $T_{\text{AMBIENT}} = 25^\circ\text{C}$, pads B and C open circuit.

— $T_{\text{AMBIENT}} = 25^\circ\text{C}$, - - $T_{\text{COLD}} = -55^\circ\text{C}$, - - - $T_{\text{HOT}} = +85^\circ\text{C}$

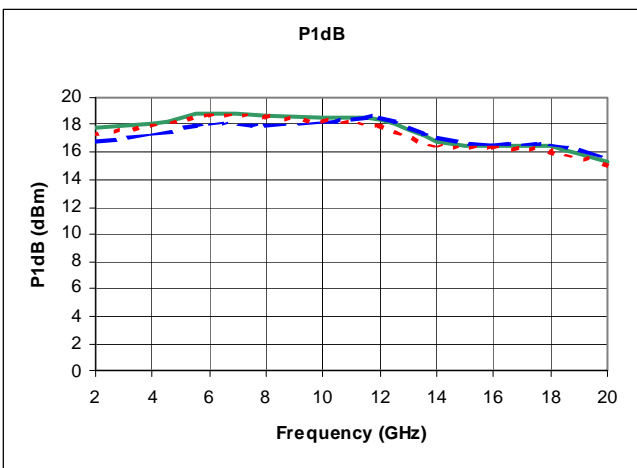
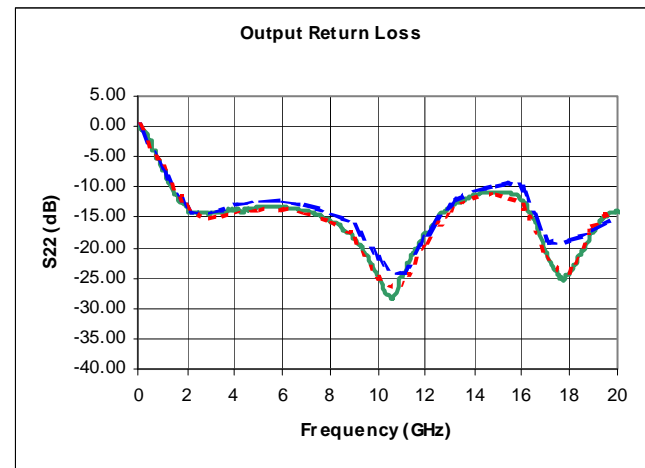
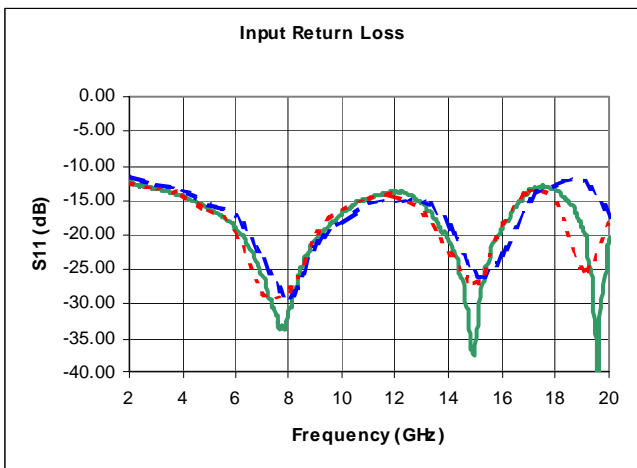
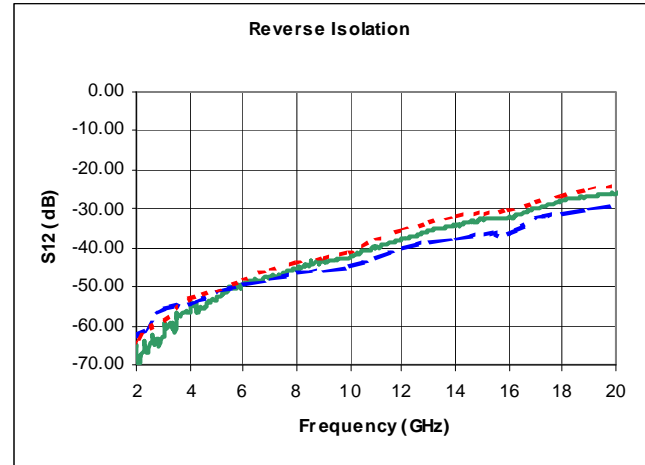
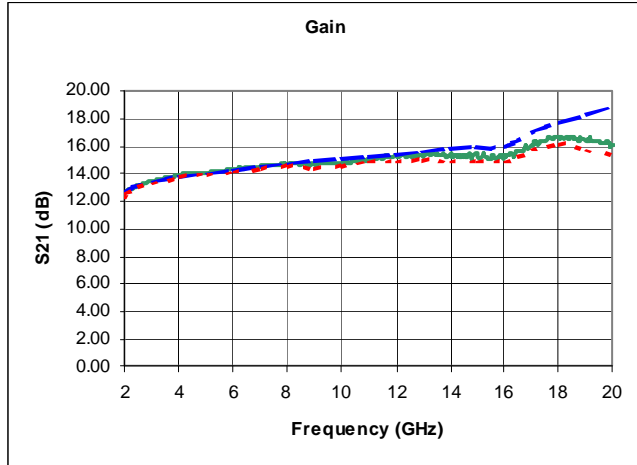

Biasing Circuit Schematic

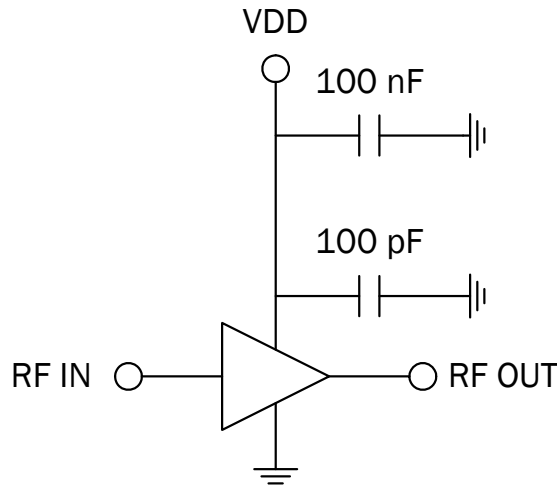

Assembly Diagram

It is recommended that the RF connections be made using bond wires with 25µm diameter and a maximum length of 300µm. Ground connections should be made according to the required bias conditions.

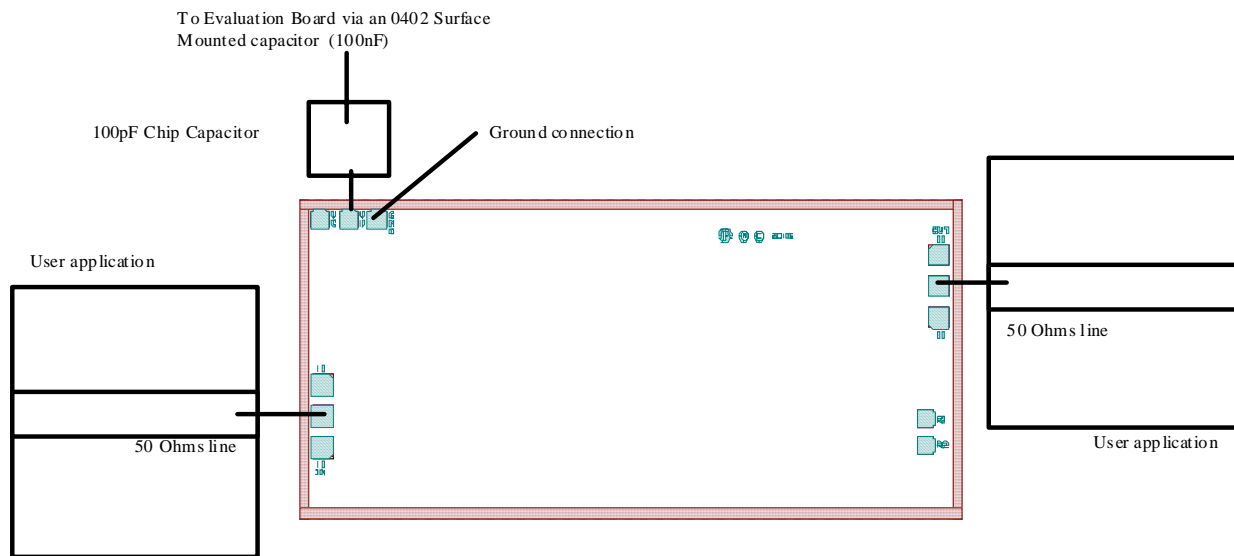

Bill of Materials

- All RF tracks should be 50Ω characteristic material.
- Capacitor, 100pF, chip capacitor.
- Capacitor, 100nF, 0402.

Preferred Assembly Instructions

GaAs devices are fragile and should be handled with great care. Specially designed collets should be used where possible.

The back of the die is metallized and the recommended mounting method is by the use of conductive epoxy. Epoxy should be applied to the attachment surface uniformly and sparingly to avoid encroachment of epoxy on to the top face of the die, and ideally should not exceed half the chip height. For automated dispense Ablestick LMISR4 is recommended, and for manual dispense Ablestick 84-1 LMI or 84-1 LMIT are recommended. These should be cured at a temperature of 150°C for 1 hour in an oven especially set aside for epoxy curing only. If possible the curing oven should be flushed with dry nitrogen. The gold-tin (80% Au 20% Sn) eutectic die attach has a melting point of approximately 280 °C but the absolute temperature being used depends on the leadframe material used and the particular application. The maximum time at used should be kept to a minimum.

This part has gold (Au) bond pads requiring the use of gold (99.99% pure) bondwire. It is recommended that 25.4µm diameter gold wire be used. Recommended lead bond technique is thermocompression wedge bonding with 0.001" (25µm) diameter wire. The bond tool force shall be 35grams to 38grams. Bonding stage temperature shall be 230 °C to 240 °C, heated tool (150 °C to 160 °C) is recommended. Ultrasonic or thermosonic bonding is not recommended.

Bonds should be made from the die first and then to the mounting substrate or package. The physical length of the bondwires should be minimized especially when making RF or ground connections.

Handling Precautions



To avoid damage to the devices, care should be exercised during handling. Proper Electrostatic Discharge (ESD) precautions should be observed at all stages of storage, handling, assembly, and testing.

ESD/MSL Rating

These devices should be treated as Class 0 (0V to 250V) using the human body model as defined in JEDEC Standard No. 22-A114. Further information on ESD control measures can be found in MIL-STD-1686 and MIL-HDBK-263. This is an unpackaged part and therefore no MSL rating applies.

Application Notes and Design Data

Application Notes and design data including S-parameters are available on request from www.rfmd.com.

Reliability

An MTTF of 4.2 million hours at a channel temperature of 150 °C is achieved for the process used to manufacture this device.

Disclaimers

This product is not designed for use in any space-based or life-sustaining/supporting equipment.

Ordering Information

Quantity	Ordering Code
Standard order quantity (waffle pack)	FMA3058-000
Small quantity (25)	FMA3058-000SQ
Sample quantity (3)	FMA3058-000S3