



RF Power Field Effect Transistor

N-Channel Enhancement-Mode Lateral MOSFET

Designed for W-CDMA base station applications with frequencies from 2110 to 2170 MHz. Suitable for FM, TDMA, CDMA and multicarrier amplifier applications. To be used in Class AB for PCN-PCS/cellular radio and WLL applications.

- W-CDMA Performance @ -45 dBc, 5 MHz Offset, 15 DTCH, 1 Perch
 Output Power — 14 Watts (Avg.)
 Power Gain — 11.5 dB
 Efficiency — 16%
- Capable of Handling 10:1 VSWR, @ 28 Vdc, 2140 MHz, 120 Watts CW
 Output Power

Features

- Internally Matched for Ease of Use
- High Gain, High Efficiency and High Linearity
- Integrated ESD Protection
- Designed for Maximum Gain and Insertion Phase Flatness
- Excellent Thermal Stability
- Characterized with Series Equivalent Large-Signal Impedance Parameters
- RoHS Compliant
- In Tape and Reel. R6 Suffix = 150 Units per 56 mm, 13 inch Reel.

MRF21120R6

**2110-2170 MHz, 120 W, 28 V
 LATERAL N-CHANNEL
 RF POWER MOSFET**

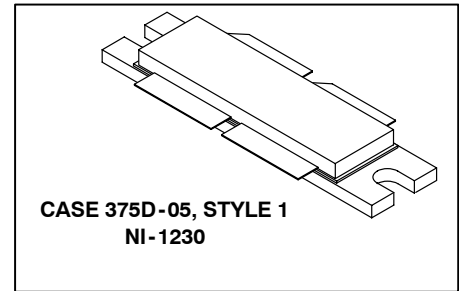

Table 1. Maximum Ratings

Rating	Symbol	Value	Unit
Drain-Source Voltage	V _{DSS}	-0.5, +65	Vdc
Gate-Source Voltage	V _{GS}	-0.5, +15	Vdc
Total Device Dissipation @ T _C = 25°C Derate above 25°C	P _D	389 2.22	W W/°C
Storage Temperature Range	T _{stg}	- 65 to +150	°C
Case Operating Temperature	T _C	150	°C
Operating Junction Temperature	T _J	200	°C

Table 2. Thermal Characteristics

Characteristic	Symbol	Value	Unit
Thermal Resistance, Junction to Case	R _{θJC}	0.45	°C/W

Table 3. ESD Protection Characteristics

Test Conditions	Class
Human Body Model	1 (Minimum)
Machine Model	M3 (Minimum)

Table 4. Electrical Characteristics ($T_C = 25^\circ\text{C}$ unless otherwise noted)

Characteristic	Symbol	Min	Typ	Max	Unit
Off Characteristics ⁽¹⁾					
Drain-Source Breakdown Voltage ($V_{GS} = 0\text{ Vdc}$, $I_D = 20\ \mu\text{Adc}$)	$V_{(BR)DSS}$	65	—	—	Vdc
Gate-Source Leakage Current ($V_{GS} = 5\text{ Vdc}$, $V_{DS} = 0\text{ Vdc}$)	I_{GSS}	—	—	1	μAdc
Zero Gate Voltage Drain Leakage Current ($V_{DS} = 28\text{ Vdc}$, $V_{GS} = 0\text{ Vdc}$)	I_{DSS}	—	—	10	μAdc
On Characteristics					
Forward Transconductance ($V_{DS} = 10\text{ Vdc}$, $I_D = 2\text{ Adc}$)	g_{fs}	—	4.8	—	S
Gate Threshold Voltage ⁽¹⁾ ($V_{DS} = 10\text{ V}$, $I_D = 200\ \mu\text{A}$)	$V_{GS(th)}$	2.5	3	3.8	Vdc
Gate Quiescent Voltage ⁽³⁾ ($V_{DS} = 28\text{ V}$, $I_D = 1000\text{ mA}$)	$V_{GS(Q)}$	3	3.9	5	Vdc
Drain-Source On-Voltage ⁽¹⁾ ($V_{GS} = 10\text{ V}$, $I_D = 2\text{ A}$)	$V_{DS(on)}$	—	0.38	0.5	Vdc
Dynamic Characteristics ^(1, 2)					
Reverse Transfer Capacitance ($V_{DS} = 28\text{ Vdc}$, $V_{GS} = 0$, $f = 1\text{ MHz}$)	C_{rss}	—	2.8	—	pF
Functional Tests ⁽³⁾ (In Freescale Test Fixture, 50 ohm system)					
Common-Source Amplifier Power Gain ($V_{DD} = 28\text{ Vdc}$, $P_{out} = 120\text{ W PEP}$, $I_{DQ} = 1000\text{ mA}$, $f_1 = 2170.0\text{ MHz}$, $f_2 = 2170.1\text{ MHz}$)	G_{ps}	10.5	11.4	—	dB
Drain Efficiency ($V_{DD} = 28\text{ Vdc}$, $P_{out} = 120\text{ W PEP}$, $I_{DQ} = 1000\text{ mA}$, $f_1 = 2170.0\text{ MHz}$, $f_2 = 2170.1\text{ MHz}$)	η	30	34.5	—	%
Intermodulation Distortion ($V_{DD} = 28\text{ Vdc}$, $P_{out} = 120\text{ W PEP}$, $I_{DQ} = 1000\text{ mA}$, $f_1 = 2170.0\text{ MHz}$, $f_2 = 2170.1\text{ MHz}$)	IMD	—	-31	-28	dB
Input Return Loss ($V_{DD} = 28\text{ Vdc}$, $P_{out} = 120\text{ W PEP}$, $I_{DQ} = 1000\text{ mA}$, $f_1 = 2170.0\text{ MHz}$, $f_2 = 2170.1\text{ MHz}$)	IRL	—	-12	-9	dB
Common-Source Amplifier Power Gain ($V_{DD} = 28\text{ Vdc}$, $P_{out} = 120\text{ W PEP}$, $I_{DQ} = 1000\text{ mA}$, $f_1 = 2140.0\text{ MHz}$, $f_2 = 2140.1\text{ MHz}$)	G_{ps}	—	11.5	—	dB
Common-Source Amplifier Power Gain ($V_{DD} = 28\text{ Vdc}$, $P_{out} = 120\text{ W PEP}$, $I_{DQ} = 1000\text{ mA}$, $f_1 = 2110.0\text{ MHz}$, $f_2 = 2110.1\text{ MHz}$)	G_{ps}	—	11.5	—	dB
Drain Efficiency ($V_{DD} = 28\text{ Vdc}$, $P_{out} = 120\text{ W PEP}$, $I_{DQ} = 1000\text{ mA}$, $f_1 = 2110.0\text{ MHz}$, $f_2 = 2110.1\text{ MHz}$)	η	—	34.5	—	%
Intermodulation Distortion ($V_{DD} = 28\text{ Vdc}$, $P_{out} = 120\text{ W PEP}$, $I_{DQ} = 1000\text{ mA}$, $f_1 = 2110.0\text{ MHz}$, $f_2 = 2110.1\text{ MHz}$)	IMD	—	-31	—	dB
Input Return Loss ($V_{DD} = 28\text{ Vdc}$, $P_{out} = 120\text{ W PEP}$, $I_{DQ} = 1000\text{ mA}$, $f_1 = 2110.0\text{ MHz}$, $f_2 = 2110.1\text{ MHz}$)	IRL	—	-12	—	dB

1. Each side of device measured separately.
2. Part internally matched both on input and output.
3. Device measured in push-pull configuration.

(continued)

Table 4. Electrical Characteristics ($T_C = 25^\circ\text{C}$ unless otherwise noted) **(continued)**

Characteristic	Symbol	Min	Typ	Max	Unit
Functional Tests (In Freescale Test Fixture, 50 ohm system) ⁽¹⁾ (continued)					
Power Output, 1 dB Compression Point ($V_{DD} = 28\text{ Vdc}$, CW, $I_{DQ} = 1000\text{ mA}$, $f_1 = 2170.0\text{ MHz}$)	P1dB	—	120	—	W
Common-Source Amplifier Power Gain ($V_{DD} = 28\text{ Vdc}$, $P_{out} = 120\text{ W CW}$, $I_{DQ} = 1000\text{ mA}$, $f_1 = 2170.0\text{ MHz}$)	G_{ps}	—	10.5	—	dB
Drain Efficiency ($V_{DD} = 28\text{ Vdc}$, $P_{out} = 120\text{ W CW}$, $I_{DQ} = 1000\text{ mA}$, $f_1 = 2170.0\text{ MHz}$)	η	—	42	—	%

1. Device measured in push-pull configuration.

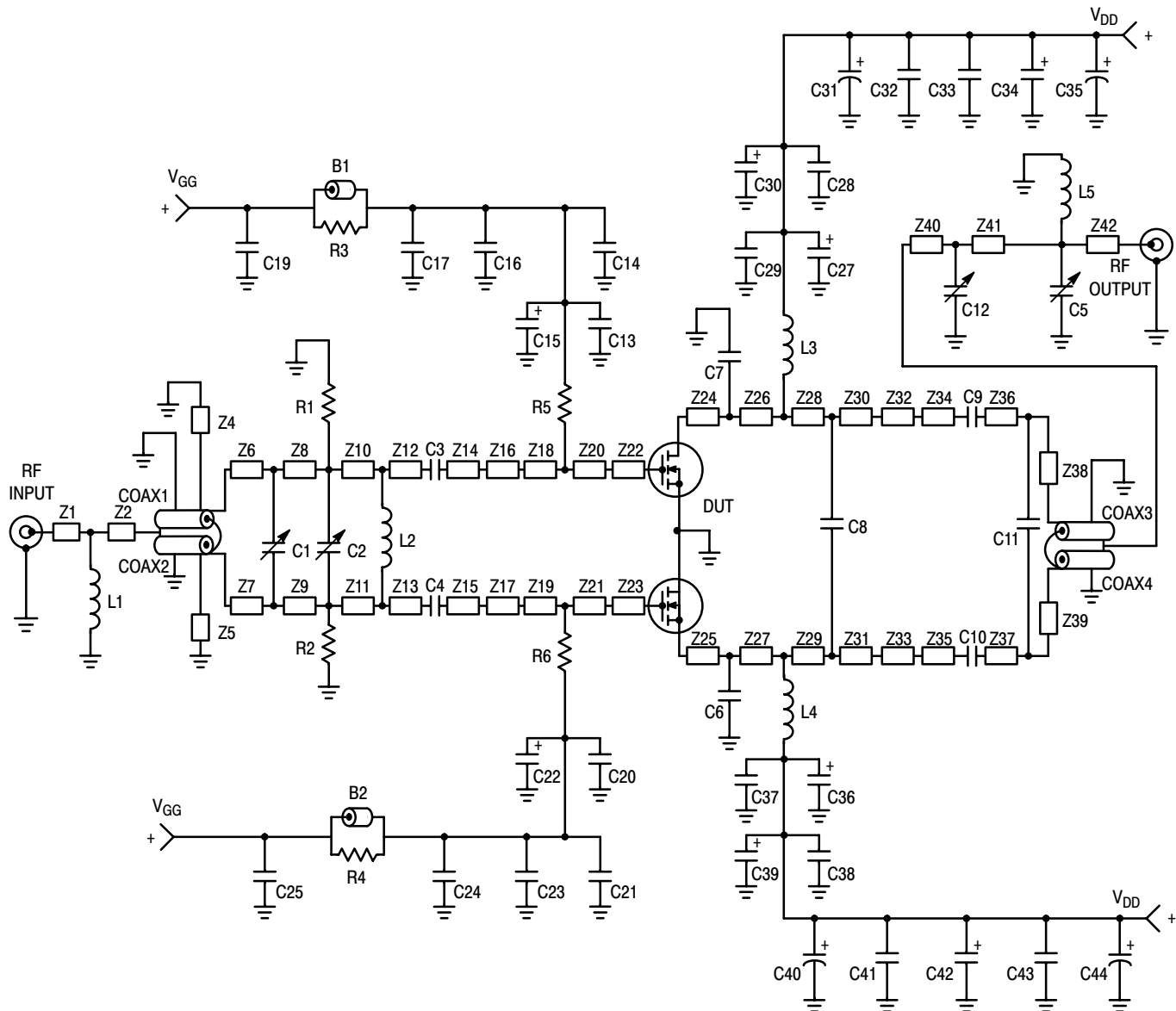

B1, B2	Ferrite Beads, Fair Rite	Z2	0.320" x 0.080" Microstrip
C1, C2, C12	0.6 - 4.5 pF Variable Capacitors, Johanson Gigatrim	Z4, Z5	1.050" x 0.080" Microstrip
C3, C4, C9, C10	10 pF Chip Capacitors, ATC	Z6, Z7	0.120" x 0.080" Microstrip
C5	0.4 - 2.5 pF Variable Capacitor, Johanson Gigatrim	Z8, Z9	0.140" x 0.080" Microstrip
C6, C7	2.0 pF Chip Capacitors, ATC	Z10, Z11	0.610" x 0.080" Microstrip
C8	0.5 pF Chip Capacitor, ATC	Z12, Z13	0.135" x 0.080" Microstrip
C11	0.2 pF Chip Capacitor, ATC	Z14, Z15	0.130" x 0.080" Microstrip
C13, C20, C29, C37	5.1 pF Chip Capacitors, ATC	Z16, Z17	0.300" x 0.350" Microstrip
C14, C21, C28, C38	91 pF Chip Capacitors, ATC	Z18, Z19	0.150" x 0.080" Microstrip
C15, C22, C27, C34, C36, C42	22 μF, 35 V Tantalum Surface Mount Chip Capacitors, Kemet	Z20, Z21	0.075" x 0.500" Microstrip
C16, C23, C33, C43	0.039 μF Chip Capacitors, ATC	Z22, Z23	0.330" x 0.500" Microstrip
C17, C24, C32, C41	1000 pF Chip Capacitors, ATC	Z24, Z25	0.100" x 0.550" Microstrip
C19, C25	0.022 μF Chip Capacitors, ATC	Z26, Z27	0.175" x 0.550" Microstrip
C30, C39	1.0 μF, 35 V Tantalum Surface Mount Chip Capacitors, Kemet	Z28, Z29	0.045" x 0.550" Microstrip
C31, C40	100 μF, 50 V Electrolytic Capacitors, Sprague	Z30, Z31	0.190" x 0.325" Microstrip
C35, C44	470 μF, 63 V Electrolytic Capacitors, Sprague	Z32, Z33	0.080" x 0.325" Microstrip
Coax1, Coax2	25 Ω Semi Rigid Coax, 70 mil OD, 1.05" Long	Z34, Z35	0.515" x 0.080" Microstrip
Coax3, Coax4	50 Ω Semi Rigid Coax, 85 mil OD, 1.05" Long	Z36, Z37	0.020" x 0.080" Microstrip
L1, L5	5.0 nH Minispring Inductors, Coilcraft	Z38, Z39	0.565" x 0.080" Microstrip
L2	8.0 nH Minispring Inductor, Coilcraft	Z40	0.100" x 0.080" Microstrip
L3, L4	7.15 nH Microspring Inductors, Coilcraft	Z41	0.470" x 0.080" Microstrip
R1, R2	1 kΩ, 1/4 W Fixed Metal Film Resistors, Dale	Z42	0.100" x 0.080" Microstrip
R3, R4	270 Ω, 1/8 W Fixed Film Chip Resistors, Dale		Board Material
R5, R6	1.2 kΩ, 1/8 W Fixed Film Chip Resistors, Dale		0.03" Teflon [®] , ε _r = 2.55 Copper
Z1	0.150" x 0.080" Microstrip		Clad, 2 oz. Cu
			Connectors
			N-Type Panel Mount, Stripline

Figure 1. 2110 - 2200 MHz Broadband Test Circuit Schematic

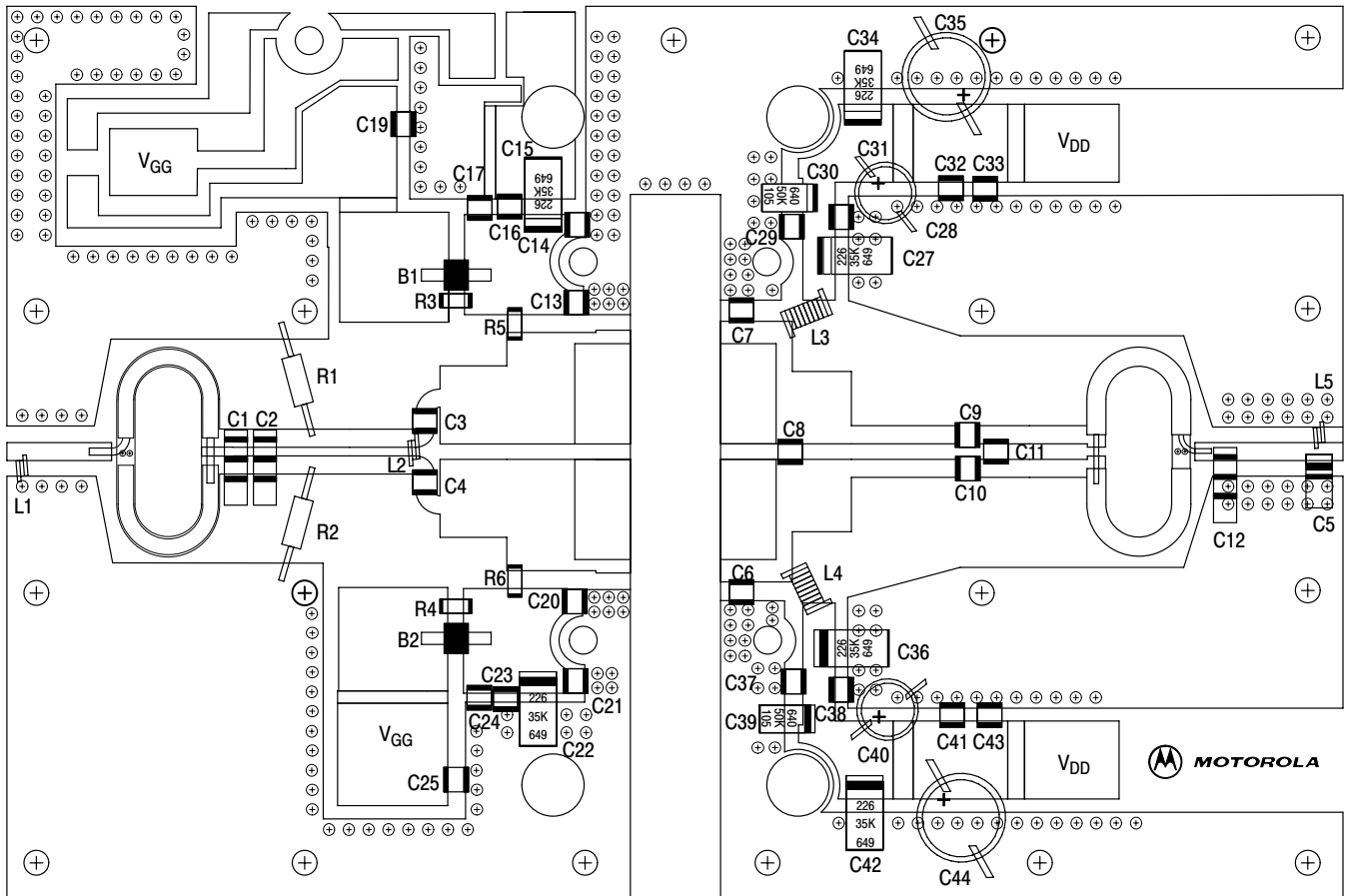

Freescale has begun the transition of marking Printed Circuit Boards (PCBs) with the Freescale Semiconductor signature/logo. PCBs may have either Motorola or Freescale markings during the transition period. These changes will have no impact on form, fit or function of the current product.

Figure 2. 2110 - 2200 MHz Broadband Test Circuit Component Layout

TYPICAL CHARACTERISTICS

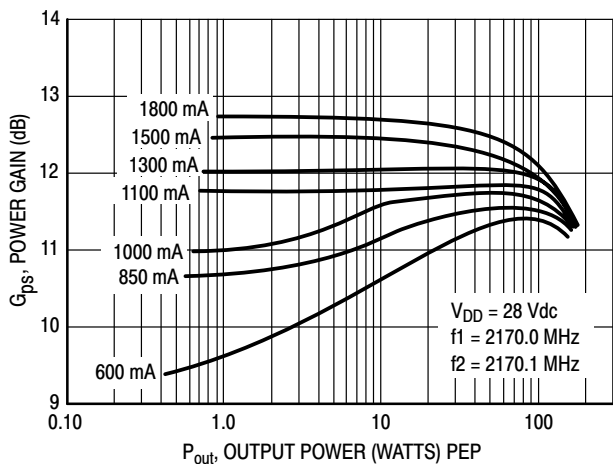

Figure 3. Power Gain versus Output Power

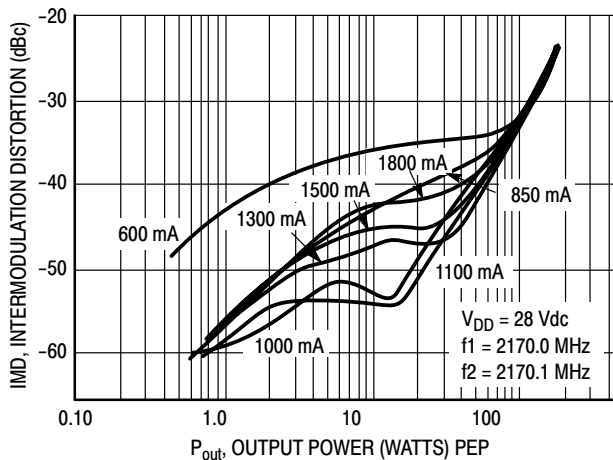

Figure 4. Intermodulation Distortion versus Output Power

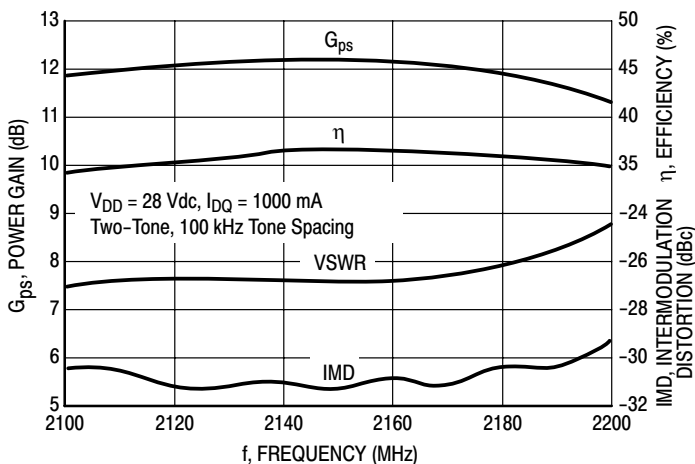

Figure 5. Class AB Broadband Circuit Performance

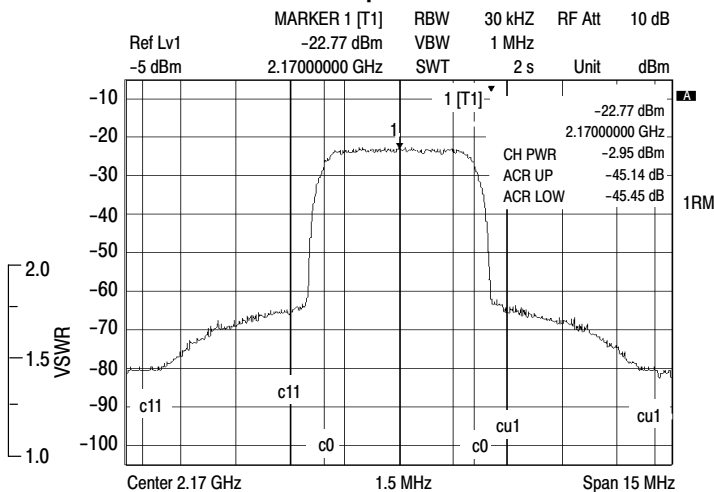

Figure 6. 2.17 GHz W-CDMA Mask at 14 Watts (Avg.), 5 MHz Offset, 15 DTCH, 1 Perch

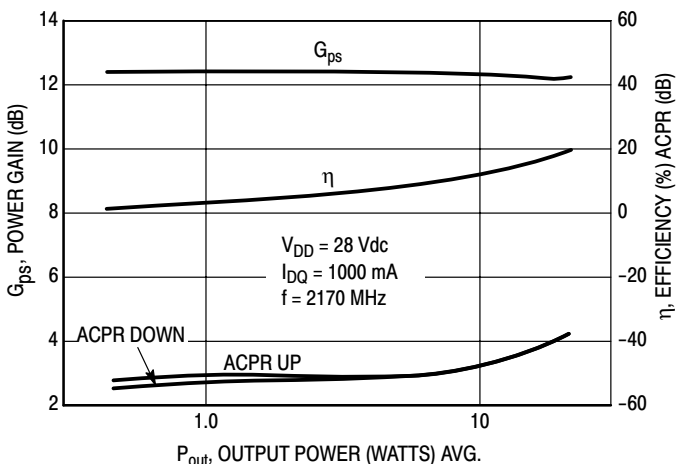

Figure 7. Power Gain, Efficiency, ACPR versus Output Power (W-CDMA)

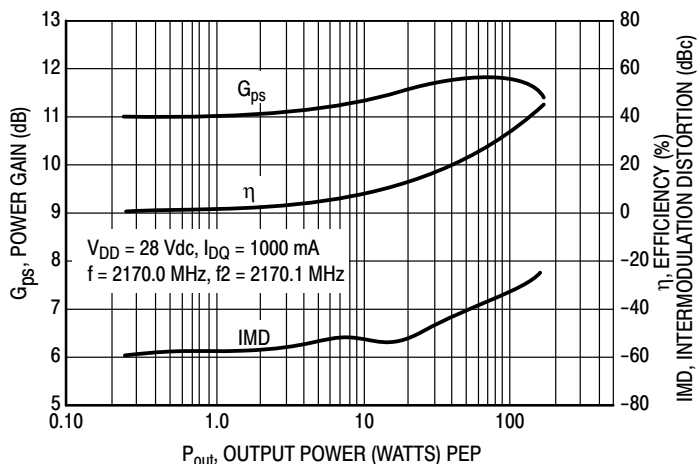
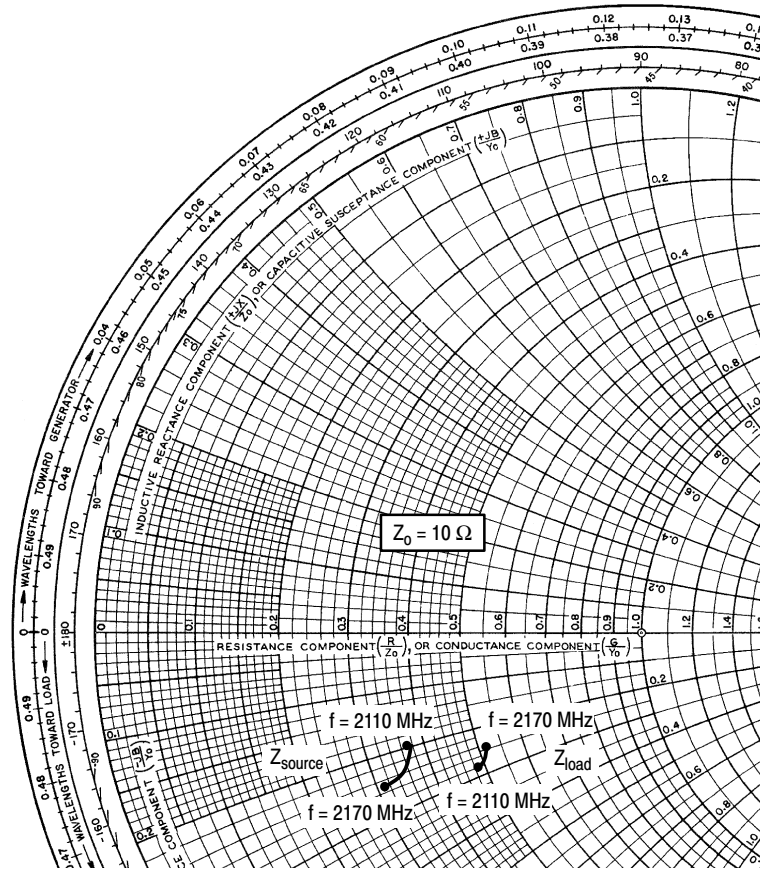

Figure 8. Power Gain, Efficiency, IMD versus Output Power



$V_{DD} = 28\text{ V}$, $I_{DQ} = 1000\text{ mA}$, $P_{out} = 120\text{ W PEP}$

f MHz	Z_{source} Ω	Z_{load} Ω
2110	$3.7 - j2.0$	$4.9 - j2.8$
2140	$3.5 - j2.4$	$5.1 - j2.7$
2170	$3.1 - j2.5$	$5.2 - j2.5$

Z_{source} = Test circuit impedance as measured from gate to gate, balanced configuration.

Z_{load} = Test circuit impedance as measured from drain to drain, balanced configuration.

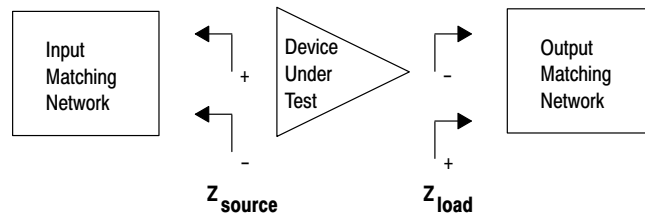

Figure 9. Series Equivalent Source and Load Impedance



NOTES



NOTES



NOTES

PACKAGE DIMENSIONS

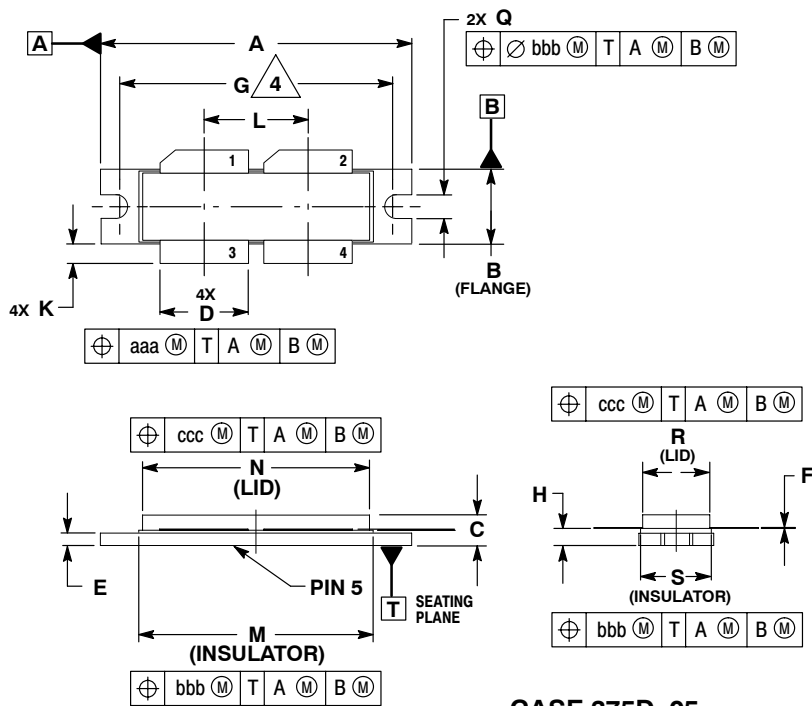

- NOTES:
1. INTERPRET DIMENSIONS AND TOLERANCES PER ASME Y14.5M-1994.
 2. CONTROLLING DIMENSION: INCH.
 3. DIMENSION H IS MEASURED 0.030 (0.762) AWAY FROM PACKAGE BODY.
 4. RECOMMENDED BOLT CENTER DIMENSION OF 1.52 (38.61) BASED ON M3 SCREW.

DIM	INCHES		MILLIMETERS	
	MIN	MAX	MIN	MAX
A	1.615	1.625	41.02	41.28
B	0.395	0.405	10.03	10.29
C	0.150	0.200	3.81	5.08
D	0.455	0.465	11.56	11.81
E	0.062	0.066	1.57	1.68
F	0.004	0.007	0.10	0.18
G	1.400 BSC		35.56 BSC	
H	0.082	0.090	2.08	2.29
K	0.117	0.137	2.97	3.48
L	0.540 BSC		13.72 BSC	
M	1.219	1.241	30.96	31.52
N	1.218	1.242	30.94	31.55
Q	0.120	0.130	3.05	3.30
R	0.355	0.365	9.01	9.27
S	0.365	0.375	9.27	9.53
aaa	0.013 REF		0.33 REF	
bbb	0.010 REF		0.25 REF	
ccc	0.020 REF		0.51 REF	

- STYLE 1:
1. DRAIN
 2. DRAIN
 3. GATE
 4. GATE
 5. SOURCE

**CASE 375D-05
ISSUE E
NI-1230**

How to Reach Us:

Home Page:

www.freescale.com

E-mail:

support@freescale.com

USA/Europe or Locations Not Listed:

Freescale Semiconductor
Technical Information Center, CH370
1300 N. Alma School Road
Chandler, Arizona 85224
+1-800-521-6274 or +1-480-768-2130
support@freescale.com

Europe, Middle East, and Africa:

Freescale Halbleiter Deutschland GmbH
Technical Information Center
Schatzbogen 7
81829 Muenchen, Germany
+44 1296 380 456 (English)
+46 8 52200080 (English)
+49 89 92103 559 (German)
+33 1 69 35 48 48 (French)
support@freescale.com

Japan:

Freescale Semiconductor Japan Ltd.
Headquarters
ARCO Tower 15F
1-8-1, Shimo-Meguro, Meguro-ku,
Tokyo 153-0064
Japan
0120 191014 or +81 3 5437 9125
support.japan@freescale.com

Asia/Pacific:

Freescale Semiconductor Hong Kong Ltd.
Technical Information Center
2 Dai King Street
Tai Po Industrial Estate
Tai Po, N.T., Hong Kong
+800 2666 8080
support.asia@freescale.com

For Literature Requests Only:

Freescale Semiconductor Literature Distribution Center
P.O. Box 5405
Denver, Colorado 80217
1-800-441-2447 or 303-675-2140
Fax: 303-675-2150
LDCForFreescaleSemiconductor@hibbertgroup.com

Information in this document is provided solely to enable system and software implementers to use Freescale Semiconductor products. There are no express or implied copyright licenses granted hereunder to design or fabricate any integrated circuits or integrated circuits based on the information in this document.

Freescale Semiconductor reserves the right to make changes without further notice to any products herein. Freescale Semiconductor makes no warranty, representation or guarantee regarding the suitability of its products for any particular purpose, nor does Freescale Semiconductor assume any liability arising out of the application or use of any product or circuit, and specifically disclaims any and all liability, including without limitation consequential or incidental damages. "Typical" parameters that may be provided in Freescale Semiconductor data sheets and/or specifications can and do vary in different applications and actual performance may vary over time. All operating parameters, including "Typicals", must be validated for each customer application by customer's technical experts. Freescale Semiconductor does not convey any license under its patent rights nor the rights of others. Freescale Semiconductor products are not designed, intended, or authorized for use as components in systems intended for surgical implant into the body, or other applications intended to support or sustain life, or for any other application in which the failure of the Freescale Semiconductor product could create a situation where personal injury or death may occur. Should Buyer purchase or use Freescale Semiconductor products for any such unintended or unauthorized application, Buyer shall indemnify and hold Freescale Semiconductor and its officers, employees, subsidiaries, affiliates, and distributors harmless against all claims, costs, damages, and expenses, and reasonable attorney fees arising out of, directly or indirectly, any claim of personal injury or death associated with such unintended or unauthorized use, even if such claim alleges that Freescale Semiconductor was negligent regarding the design or manufacture of the part.

Freescale™ and the Freescale logo are trademarks of Freescale Semiconductor, Inc. All other product or service names are the property of their respective owners.
© Freescale Semiconductor, Inc. 2006. All rights reserved.

