

The RF Sub-Micron MOSFET Line
RF Power Field Effect Transistors
N-Channel Enhancement-Mode Lateral MOSFETs

Designed for GSM 900 MHz frequency band, the high gain and broadband performance of these devices make them ideal for large-signal, common-source amplifier applications in 26 volt base station equipment.

- Typical Performance for GSM Frequencies, 921 to 960 MHz, 26 Volts
Output Power @ P1db: 75 Watts
Power Gain @ P1db: 18.5 dB
Efficiency @ P1db: 55%
- Internally Matched, Controlled Q, for Ease of Use
- High Gain, High Efficiency and High Linearity
- Integrated ESD Protection
- Designed for Maximum Gain and Insertion Phase Flatness
- Capable of Handling 5:1 VSWR, @ 26 Vdc, 921 MHz, 90 Watts CW Output Power
- Excellent Thermal Stability
- Characterized with Series Equivalent Large-Signal Impedance Parameters
- Available in Tape and Reel. R3 Suffix = 250 Units per 56 mm, 13 inch Reel.
- Available with Low Gold Plating Thickness on Leads. L Suffix Indicates 40μ" Nominal.

MRF9080
MRF9080R3
MRF9080SR3
MRF9080LSR3

**GSM 900 MHz FREQUENCY BAND,
75 W, 26 V
LATERAL N-CHANNEL
BROADBAND RF POWER MOSFETs**

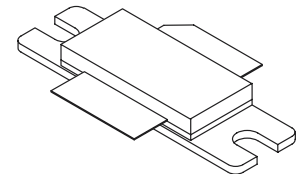

**CASE 465-06, STYLE 1
NI-780
MRF9080**

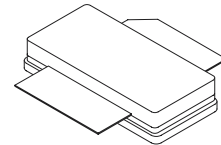

**CASE 465A-06, STYLE 1
NI-780S
MRF9080SR3, MRF9080LSR3**

MAXIMUM RATINGS

Rating	Symbol	Value	Unit
Drain-Source Voltage	V _{DSS}	65	Vdc
Gate-Source Voltage	V _{GS}	-0.5, +15	Vdc
Total Device Dissipation @ T _C = 25°C Derate above 25°C	P _D	250 1.43	Watts W/°C
Storage Temperature Range	T _{stg}	-65 to +200	°C
Operating Junction Temperature	T _J	200	°C

ESD PROTECTION CHARACTERISTICS

Test Conditions	Class
Human Body Model	1 (Minimum)
Machine Model	M1 (Minimum)

THERMAL CHARACTERISTICS

Characteristic	Symbol	Max	Unit
Thermal Resistance, Junction to Case	R _{θJC}	0.7	°C/W

NOTE – **CAUTION** – MOS devices are susceptible to damage from electrostatic charge. Reasonable precautions in handling and packaging MOS devices should be observed.

ELECTRICAL CHARACTERISTICS ($T_C = 25^\circ\text{C}$ unless otherwise noted)

Characteristic	Symbol	Min	Typ	Max	Unit
OFF CHARACTERISTICS					
Zero Gate Voltage Drain Leakage Current ($V_{DS} = 65\text{ Vdc}$, $V_{GS} = 0$)	I_{DSS}	—	—	10	μAdc
Zero Gate Voltage Drain Leakage Current ($V_{DS} = 26\text{ Vds}$, $V_{GS} = 0$)	I_{DSS}	—	—	1	μAdc
Gate–Source Leakage Current ($V_{GS} = 5\text{ Vdc}$, $V_{DS} = 0$)	I_{GSS}	—	—	1	μAdc

ON CHARACTERISTICS

Gate Threshold Voltage ($V_{DS} = 10\text{ Vdc}$, $I_D = 300\ \mu\text{Adc}$)	$V_{GS(th)}$	2.0	—	4.0	Vdc
Gate Quiescent Voltage ($V_{DS} = 26\text{ Vdc}$, $I_D = 700\ \text{mAdc}$)	$V_{GS(Q)}$	—	3.7	—	Vdc
Drain–Source On–Voltage ($V_{GS} = 10\text{ Vdc}$, $I_D = 2\ \text{Adc}$)	$V_{DS(on)}$	—	0.19	0.4	Vdc
Forward Transconductance ($V_{DS} = 10\text{ Vdc}$, $I_D = 6\ \text{Adc}$)	g_{fs}	—	8.0	—	S

DYNAMIC CHARACTERISTICS (1)

Output Capacitance ($V_{DS} = 26\text{ Vdc}$, $V_{GS} = 0$, $f = 1\ \text{MHz}$)	C_{oss}	—	73	—	pF
Reverse Transfer Capacitance ($V_{DS} = 26\text{ Vdc}$, $V_{GS} = 0$, $f = 1\ \text{MHz}$)	C_{rss}	—	2.9	—	pF

FUNCTIONAL TESTS (In Motorola Test Fixture, 50 ohm system) (2)

Power Output, 1 dB Compression Point ($V_{DD} = 26\text{ Vdc}$, $I_{DQ} = 600\ \text{mA}$, $f = 921$ and $960\ \text{MHz}$)	P_{1dB}	68	75	—	W
Common–Source Amplifier Power Gain @ 70 W (Min) ($V_{DD} = 26\text{ Vdc}$, $I_{DQ} = 600\ \text{mA}$, $f = 921$ and $960\ \text{MHz}$)	G_{ps}	17	18.5	20	dB
Drain Efficiency @ $P_{out} = 70\ \text{W}$ ($V_{DD} = 26\text{ Vdc}$, $I_{DQ} = 600\ \text{mA}$, $f = 921$ and $960\ \text{MHz}$)	η_1	47	52	—	%
Drain Efficiency @ P1dB ($V_{DD} = 26\text{ Vdc}$, $I_{DQ} = 600\ \text{mA}$, $f = 921$ and $960\ \text{MHz}$)	η_2	—	55	—	%
Input Return Loss ($V_{DD} = 26\text{ Vdc}$, $P_{out} = 70\ \text{W}$, $I_{DQ} = 600\ \text{mA}$, $f = 921$ and $960\ \text{MHz}$)	IRL	9.5	12.5	—	dB
Output Mismatch Stress ($V_{DD} = 26\text{ Vdc}$, $P_{out} = 90\ \text{W CW}$, $I_{DQ} = 600\ \text{mA}$, $f = 921\ \text{MHz}$, $V_{SWR} = 5:1$, All Phase Angles at Frequency of Tests)	Ψ	No Degradation In Output Power Before and After Test			

(1) Part is internally input matched.

(2) To meet application requirements, Motorola test fixtures are designed to cover full GSM 900 band ensuring batch to batch consistency

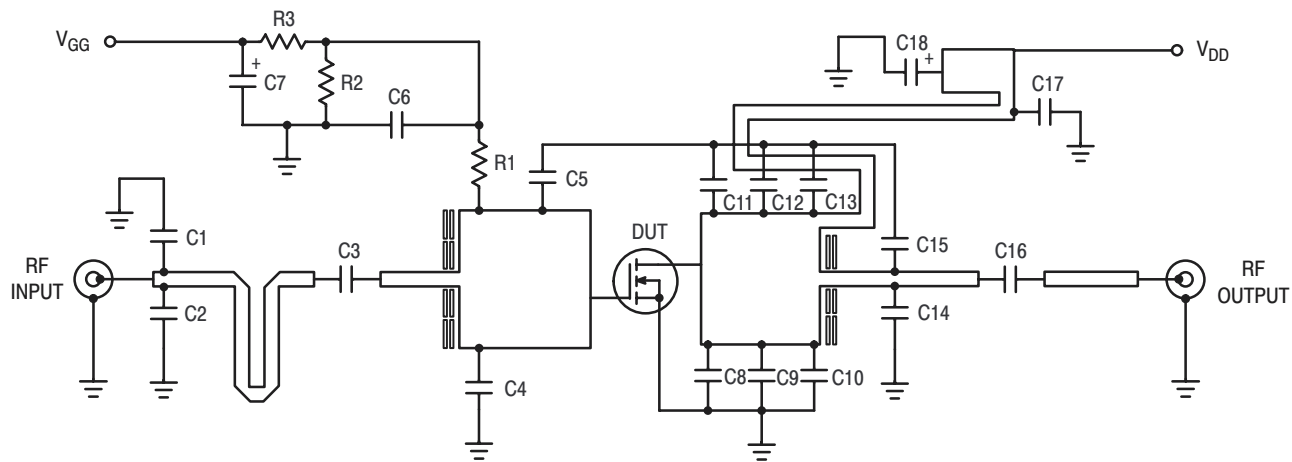

Figure 1. Broadband GSM 900 Test Circuit Schematic

Table 1. Broadband GSM 900 Test Circuit Component Designations and Values

Part	Description	Value, P/N or DWG	Manufacturer
C1	4.7 pF Chip Capacitor, B Case	100B4R7BW	ATC
C2	2.7 pF Chip Capacitor, B Case	100B2R7BW	ATC
C3	1.5 pF Chip Capacitor, B Case	100B1R5BW	ATC
C4, C5, C9, C10, C12, C13	5.6 pF Chip Capacitors, B Case	100B5R6CW	ATC
C6, C16, C17	22 pF Chip Capacitors, B Case	100B220GW	ATC
C7, C18	10 μ F, 35 V Tantalum Chip Capacitors	293D106X9035D2T	Sprague-Vishay
C8, C11	10 pF Chip Capacitors, B Case	100B100JW	ATC
C14	0.8 pF Chip Capacitor, B Case	100B0R8BW	ATC
C15	8.2 pF Chip Capacitor, B Case	100B8R2GW	ATC
R1, R2, R3	1.0 k Ω , ??? W Chip Resistors (0805)		
WB1, WB2	Beryllium Copper Wear Blocks	0.004" x 0.210" x 0.520"	
Raw PCB Material	30 mil Glass Teflon [®] , $\epsilon_r = 2.55$	TLX8-0300	Taconic
PCB	Etched Circuit Board	C-GY-00-001-02	Cibel

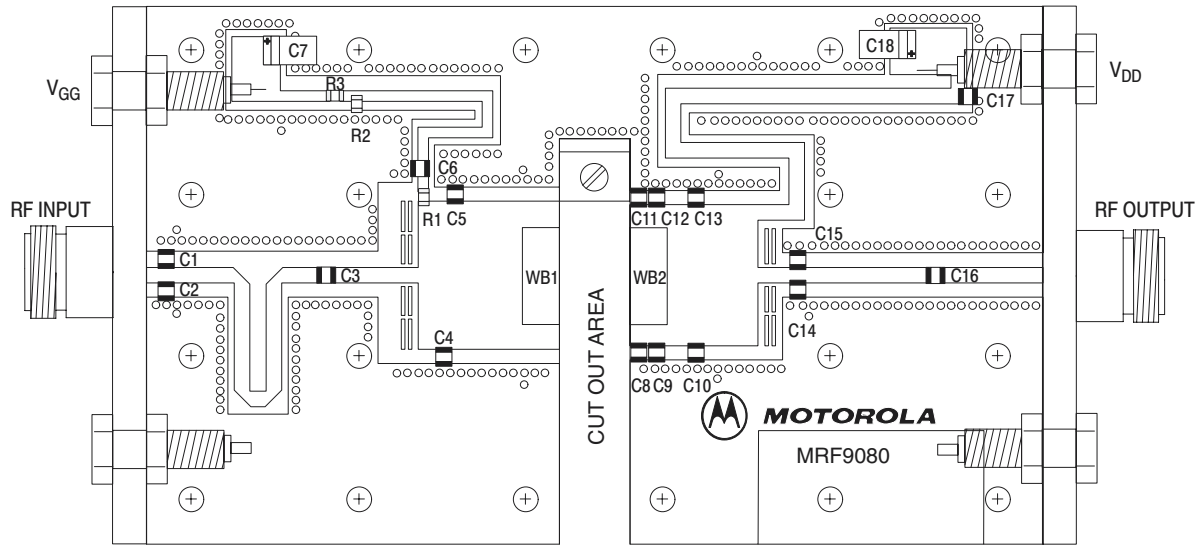

Figure 2. Broadband GSM 900 Test Circuit Component Layout

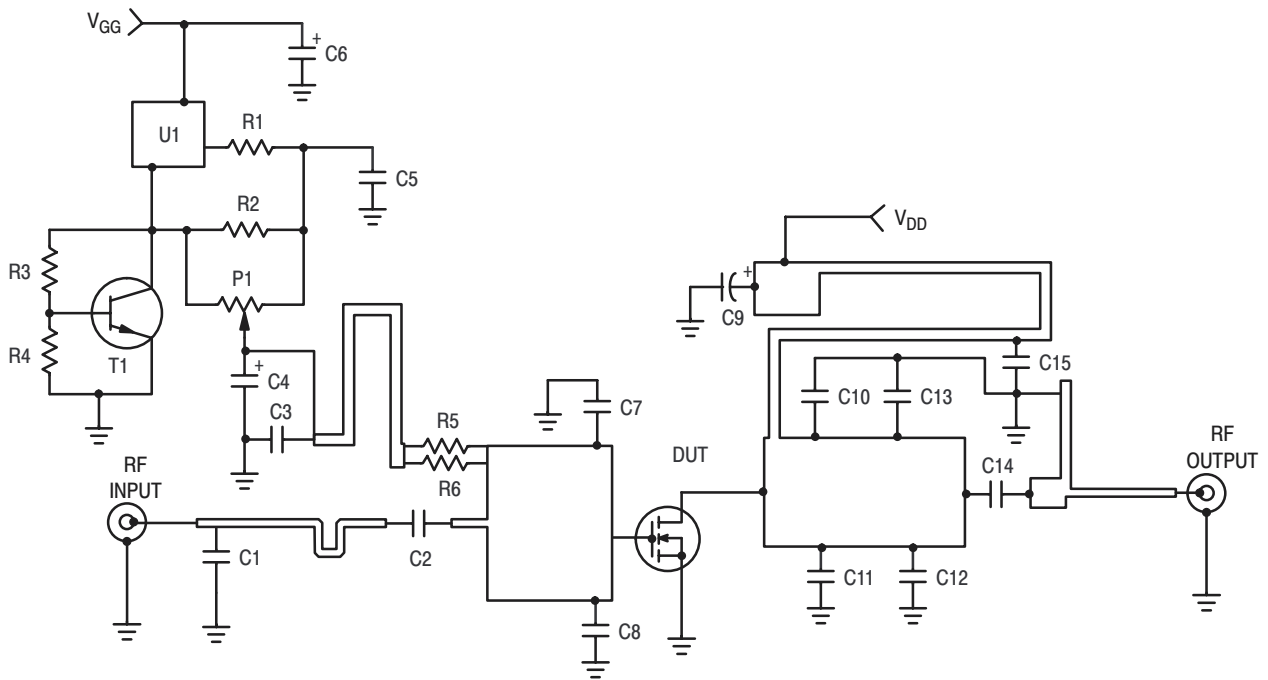

Figure 3. Broadband GSM 900 Optimized Demo Board Schematic

Table 2. Broadband GSM 900 Optimized Demo Board Component Designations and Values

Part	Description	Value, P/N or DWG	Manufacturer
C1	4.7 pF Chip Capacitor, ACCU-P (0805)	#08051J3R9CBT	AVX
C2	3.9 pF Chip Capacitor, ACCU-P (0805)	#08051J3R9CBT	AVX
C3, C15	22 pF Chip Capacitors, ACCU-P (0805)	#08051J221	AVX
C4, C6	22 μ F, 35 V Tantalum Chip Capacitors	#T491X226K035AS4394	Kemet
C5	1.0 μ F Chip Capacitor, ACCU-P (0805)	#08053G105ZATEA	AVX
C7, C8	5.6 pF Chip Capacitors, ACCU-P (0805)	#08051J5R18CBT	AVX
C9	220 μ F, 63 V Electrolytic Capacitor		
C10, C11	3.3 pF Chip Capacitors, ACCU-P (0805)	#08051J8R2CBT	AVX
C12, C13	2.2 pF Chip Capacitors, ACCU-P (0805)	#08051J2R2CBT	AVX
C14	4.7 pF Chip Capacitor	#100B	ATC
P1	5.0 k Ω Potentiometer CMS Cermet Multi-turn	#3224W	Bourns
R1	10 Ω , 1/8 W Chip Resistor (0805)		
R2	1.0 k Ω , 1/8 W Chip Resistor (0805)		
R3	1.2 k Ω , 1/8 W Chip Resistor (0805)		
R4	2.2 k Ω , 1/8 W Chip Resistor (0805)		
R5, R6	1.0 k Ω , 1/8 W Chip Resistors (0805)		
T1	Bipolar NPN Transistor, SOT-23	#BC847ALT1	ON Semiconductor
U1	Voltage Regulator, Micro-8	#LP2951ACDM-5.0R2	ON Semiconductor
	RF Connectors, Type SMA	#R125510001	Radial
	Substrate = Taconic RF35, Thickness 0.5 mm		

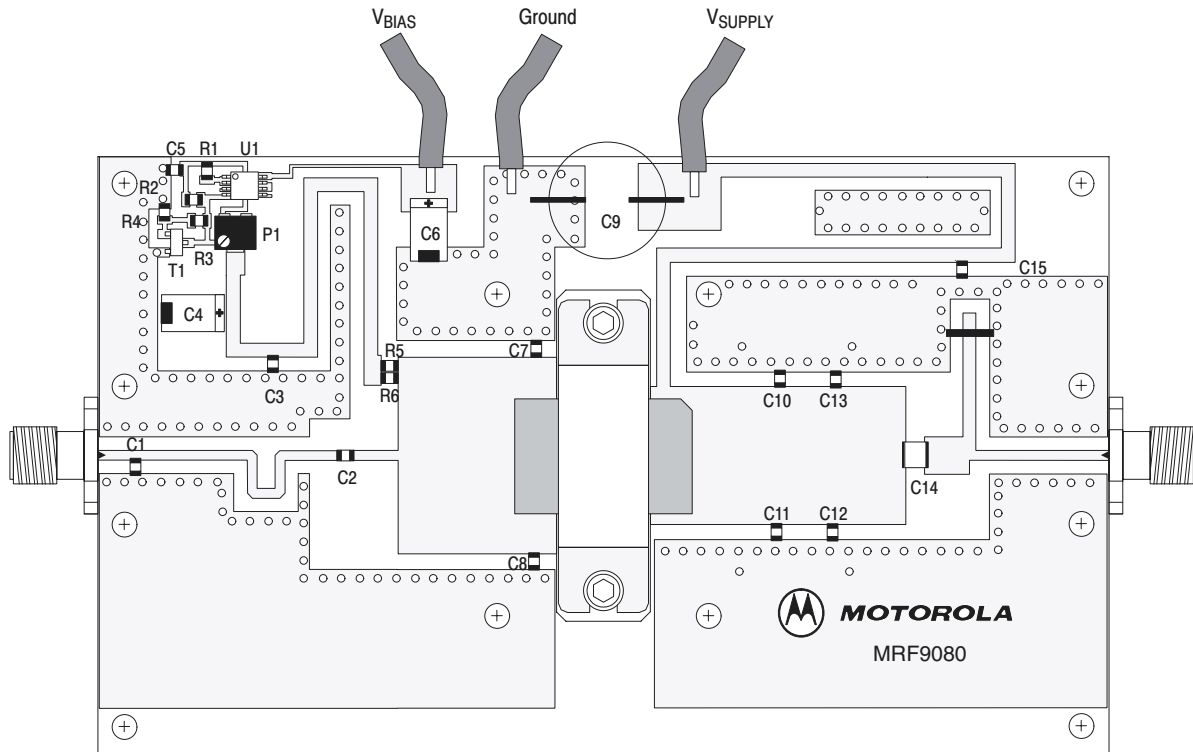

Figure 4. Broadband GSM 900 Optimized Demo Board Component Layout

**TYPICAL CHARACTERISTICS
(IN MOTOROLA BROADBAND GSM 900 OPTIMIZED DEMO BOARD)**

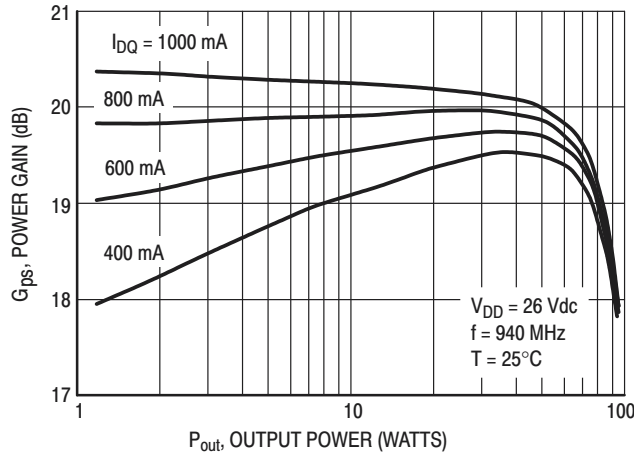

Figure 5. Power Gain versus Output Power

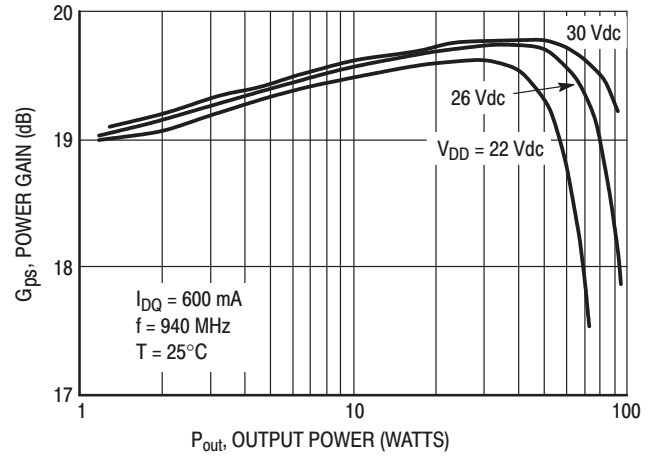

Figure 6. Power Gain versus Output Power

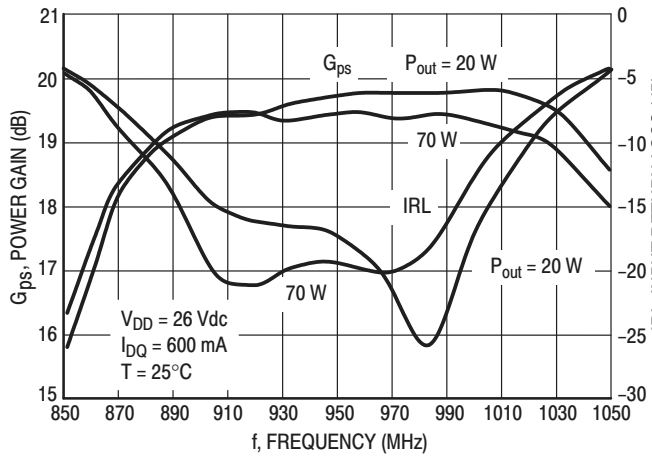

Figure 7. Power Gain and Input Return Loss versus Frequency

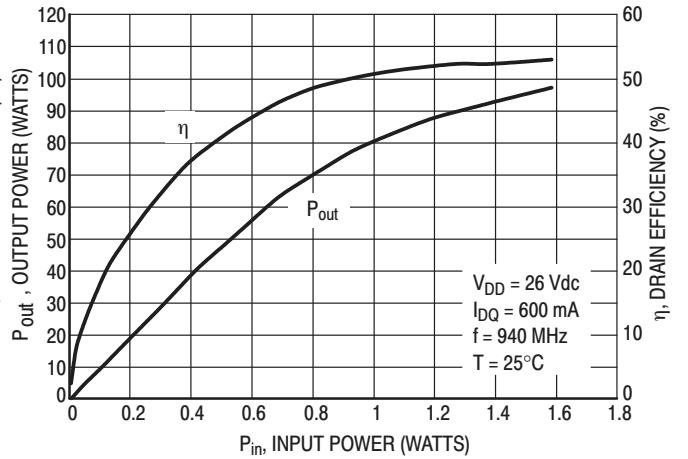

Figure 8. Output Power and Efficiency versus Input Power

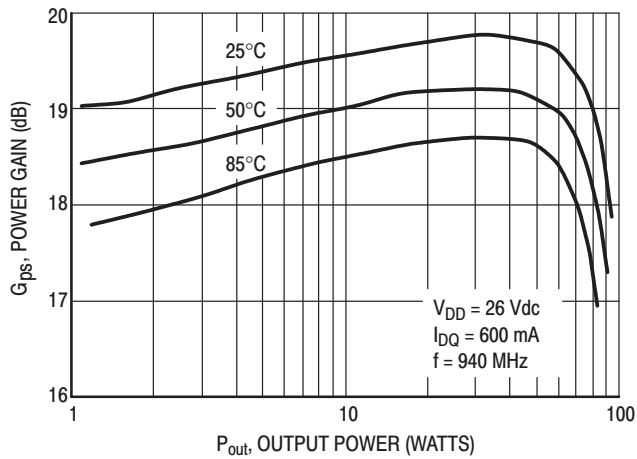

Figure 9. Power Gain versus Output Power

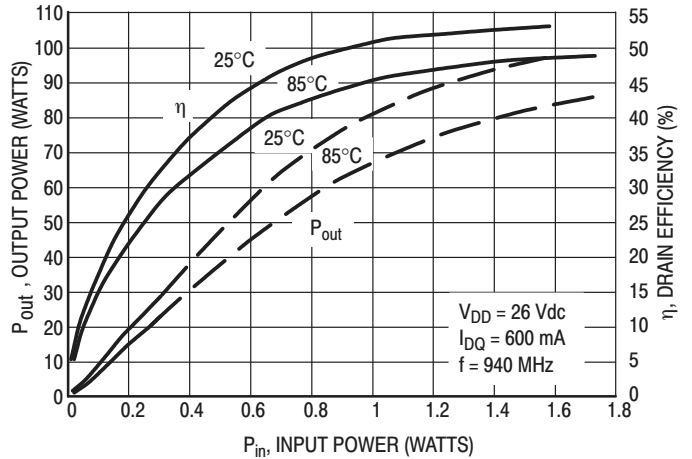
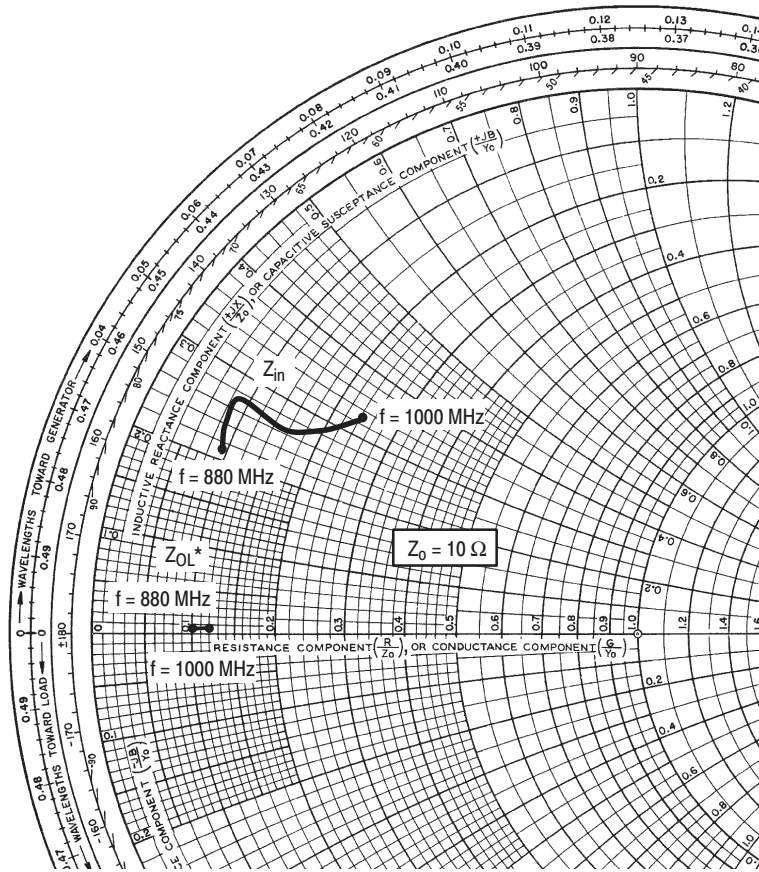

Figure 10. Output Power and Efficiency versus Input Power



$V_{DD} = 26\text{ V}$, $I_{DQ} = 600\text{ mA}$, $P_{out} = 90\text{ W CW}$

f MHz	Z_{in} Ω	Z_{OL}^* Ω
880	$0.91 + j2.11$	$1.22 + j0.12$
920	$0.88 + j2.65$	$1.00 + j0.16$
960	$1.6 + j2.61$	$1.22 + j0.22$
1000	$2.45 + j3.38$	$1.14 + j0.41$

Z_{in} = Complex conjugate of source impedance.

Z_{OL}^* = Complex conjugate of the optimum load impedance at a given output power, voltage, bias current and frequency.

Note: Z_{OL}^* was chosen based on tradeoffs between gain, output power and drain efficiency.

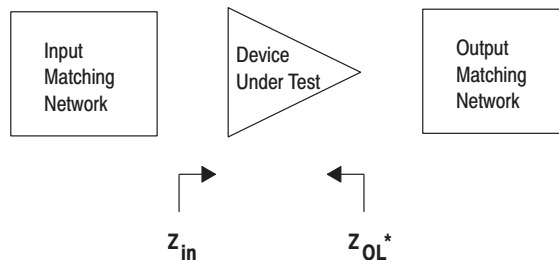
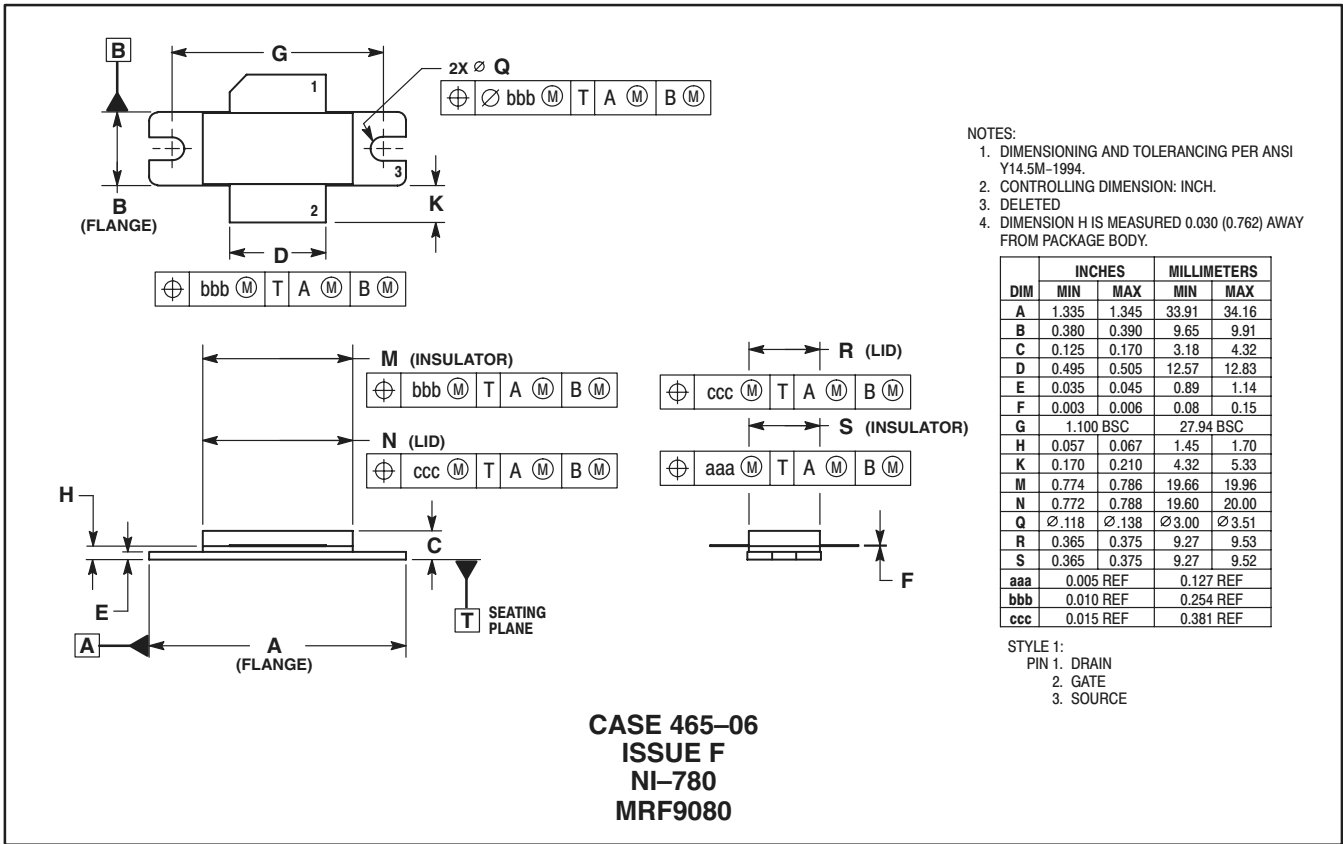

Figure 11. Series Equivalent Input and Output Impedance

NOTES

NOTES

PACKAGE DIMENSIONS



- NOTES:
1. DIMENSIONING AND TOLERANCING PER ANSI Y14.5M-1994.
 2. CONTROLLING DIMENSION: INCH.
 3. DELETED
 4. DIMENSION H IS MEASURED 0.030 (0.762) AWAY FROM PACKAGE BODY.

DIM	INCHES		MILLIMETERS	
	MIN	MAX	MIN	MAX
A	1.335	1.345	33.91	34.16
B	0.380	0.390	9.65	9.91
C	0.125	0.170	3.18	4.32
D	0.495	0.505	12.57	12.83
E	0.035	0.045	0.89	1.14
F	0.003	0.006	0.08	0.15
G	1.100 BSC		27.94 BSC	
H	0.057	0.067	1.45	1.70
K	0.170	0.210	4.32	5.33
M	0.774	0.786	19.66	19.96
N	0.772	0.788	19.60	20.00
Q	∅.118	∅.138	∅3.00	∅3.51
R	0.365	0.375	9.27	9.53
S	0.365	0.375	9.27	9.52
aaa	0.005 REF		0.127 REF	
bbb	0.010 REF		0.254 REF	
ccc	0.015 REF		0.381 REF	

- STYLE 1:
PIN 1. DRAIN
2. GATE
3. SOURCE

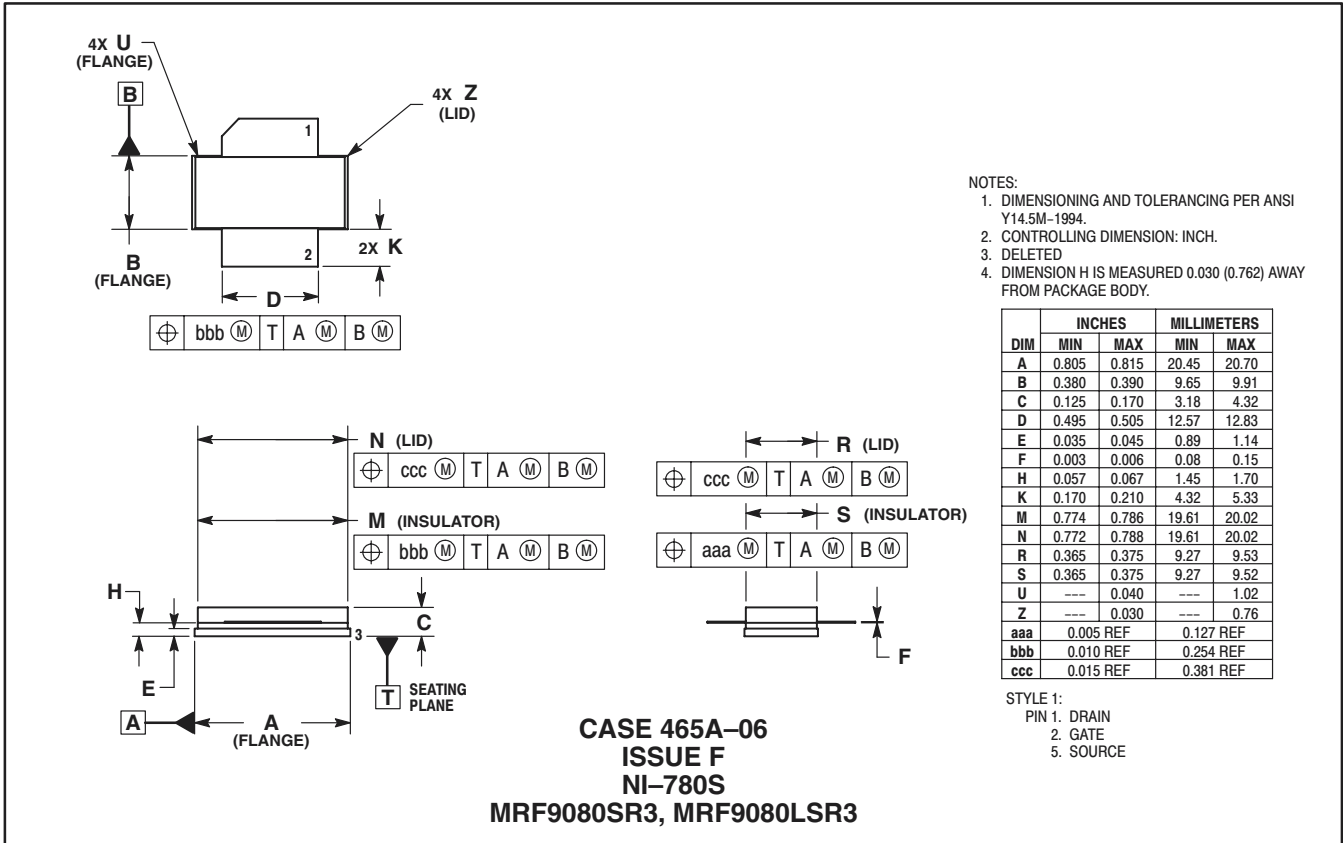

- NOTES:
1. DIMENSIONING AND TOLERANCING PER ANSI Y14.5M-1994.
 2. CONTROLLING DIMENSION: INCH.
 3. DELETED
 4. DIMENSION H IS MEASURED 0.030 (0.762) AWAY FROM PACKAGE BODY.

DIM	INCHES		MILLIMETERS	
	MIN	MAX	MIN	MAX
A	0.805	0.815	20.45	20.70
B	0.380	0.390	9.65	9.91
C	0.125	0.170	3.18	4.32
D	0.495	0.505	12.57	12.83
E	0.035	0.045	0.89	1.14
F	0.003	0.006	0.08	0.15
H	0.057	0.067	1.45	1.70
K	0.170	0.210	4.32	5.33
M	0.774	0.786	19.61	20.02
N	0.772	0.788	19.61	20.02
R	0.365	0.375	9.27	9.53
S	0.365	0.375	9.27	9.52
U	---	0.040	---	1.02
Z	---	0.030	---	0.76
aaa	0.005 REF		0.127 REF	
bbb	0.010 REF		0.254 REF	
ccc	0.015 REF		0.381 REF	

- STYLE 1:
PIN 1. DRAIN
2. GATE
5. SOURCE

Motorola reserves the right to make changes without further notice to any products herein. Motorola makes no warranty, representation or guarantee regarding the suitability of its products for any particular purpose, nor does Motorola assume any liability arising out of the application or use of any product or circuit, and specifically disclaims any and all liability, including without limitation consequential or incidental damages. "Typical" parameters which may be provided in Motorola data sheets and/or specifications can and do vary in different applications and actual performance may vary over time. All operating parameters, including "Typicals" must be validated for each customer application by customer's technical experts. Motorola does not convey any license under its patent rights nor the rights of others. Motorola products are not designed, intended, or authorized for use as components in systems intended for surgical implant into the body, or other applications intended to support or sustain life, or for any other application in which the failure of the Motorola product could create a situation where personal injury or death may occur. Should Buyer purchase or use Motorola products for any such unintended or unauthorized application, Buyer shall indemnify and hold Motorola and its officers, employees, subsidiaries, affiliates, and distributors harmless against all claims, costs, damages, and expenses, and reasonable attorney fees arising out of, directly or indirectly, any claim of personal injury or death associated with such unintended or unauthorized use, even if such claim alleges that Motorola was negligent regarding the design or manufacture of the part. Motorola, Inc. Motorola, Inc. is an Equal Opportunity/Affirmative Action Employer. MOTOROLA and the  logo are registered in the US Patent & Trademark Office. All other product or service names are the property of their respective owners.

© Motorola, Inc. 2002.

How to reach us:

USA/EUROPE/Locations Not Listed: Motorola Literature Distribution; P.O. Box 5405, Denver, Colorado 80217. 1-303-675-2140 or 1-800-441-2447

JAPAN: Motorola Japan Ltd.; SPS, Technical Information Center, 3-20-1, Minami-Azabu. Minato-ku, Tokyo 106-8573 Japan. 81-3-3440-3569

ASIA/PACIFIC: Motorola Semiconductors H.K. Ltd.; Silicon Harbour Centre, 2 Dai King Street, Tai Po Industrial Estate, Tai Po, N.T., Hong Kong. 852-26668334

Technical Information Center: 1-800-521-6274

HOME PAGE: <http://www.motorola.com/semiconductors/>

