

# Single pole double throw (SPDT) switch

NE/SA630

## DESCRIPTION

The NE630 is a wideband RF switch fabricated in BiCMOS technology and incorporating on-chip CMOS/TTL compatible drivers. Its primary function is to switch signals in the frequency range DC - 1GHz from one 50Ω channel to another. The switch is activated by a CMOS/TTL compatible signal applied to the enable channel 1 pin (ENCH1).

The extremely low current consumption makes the NE/SA630 ideal for portable applications. The excellent isolation and low loss makes this a suitable replacement for PIN diodes.

The NE/SA630 is available in an 8-pin dual in-line plastic package and an 8-pin SO (surface mounted miniature) package.

## FEATURES

- Wideband (DC - 1GHz)
- Low through loss (1dB typical at 200MHz)
- Unused input is terminated internally in 50Ω
- Excellent overload capability (1dB gain compression point +18dBm at 300MHz)
- Low DC power (170μA from 5V supply)
- Fast switching (20ns typical)
- Good isolation (off channel isolation 60dB at 100MHz)

## PIN CONFIGURATION

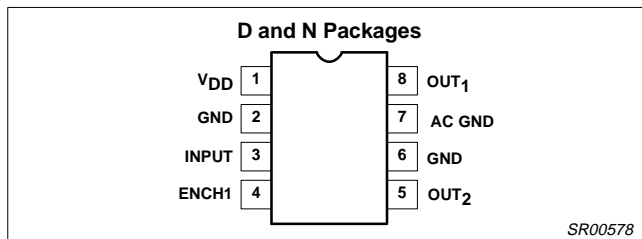

Figure 1. Pin Configuration

- Low distortion (IP<sub>3</sub> intercept +33dBm)
- Good 50Ω match (return loss 18dB at 400MHz)
- Full ESD protection
- Bidirectional operation

## APPLICATIONS

- Digital transceiver front-end switch
- Antenna switch
- Filter selection
- Video switch
- FSK transmitter

## ORDERING INFORMATION

DESCRIPTION	TEMPERATURE RANGE	ORDER CODE	DWG #
8-Pin Plastic Dual In-Line Package (DIP)	0 to 70°C	NE630N	SOT97-1
8-Pin Plastic Small Outline (SO) package (Surface-mount)	0 to 70°C	NE630D	SOT96-1
8-Pin Plastic Dual In-Line Package (DIP)	-40 to +85°C	SA630N	SOT97-1
8-Pin Plastic Small Outline (SO) package (Surface-mount)	-40 to +85°C	SA630D	SOT96-1

## BLOCK DIAGRAM

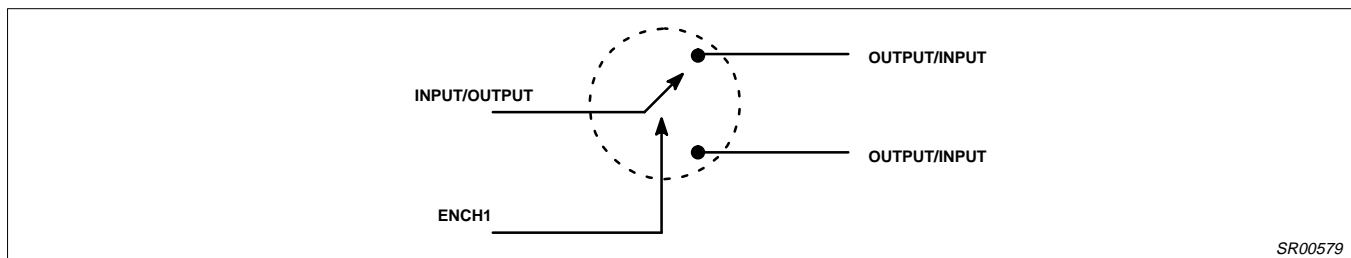

Figure 2. Block Diagram

## RECOMMENDED OPERATING CONDITIONS

SYMBOL	PARAMETER	RATING	UNITS
V <sub>DD</sub>	Supply voltage	3.0 to 5.5V	V
T <sub>A</sub>	Operating ambient temperature range NE Grade SA Grade	0 to +70 -40 to +85	°C °C
T <sub>J</sub>	Operating junction temperature range NE Grade SA Grade	0 to +90 -40 to +105	°C °C

## Single pole double throw (SPDT) switch

NE/SA630

## EQUIVALENT CIRCUIT

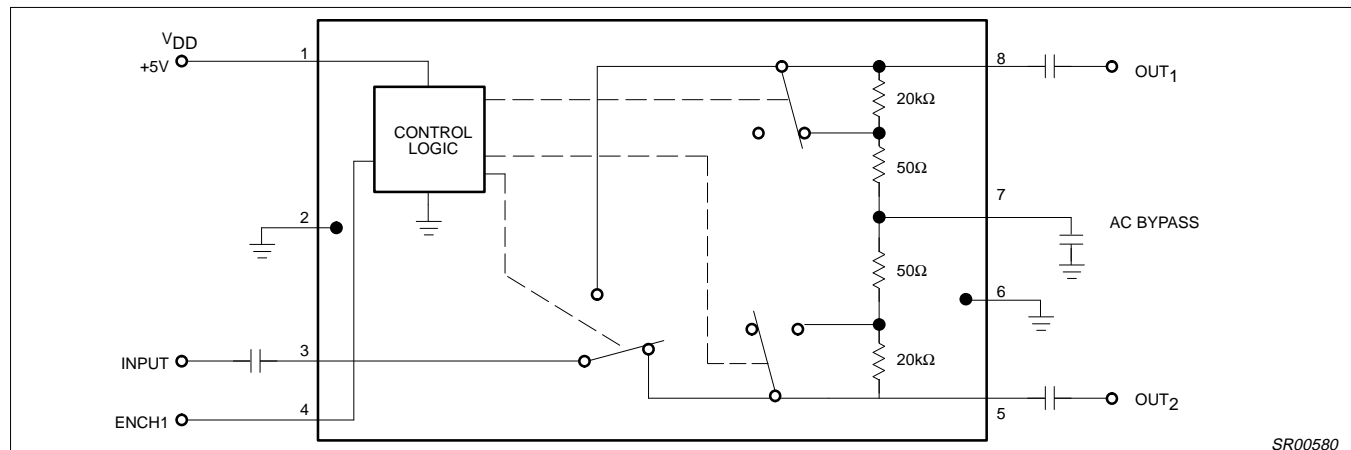

SR00580

Figure 3. Equivalent Circuit

## ABSOLUTE MAXIMUM RATINGS

SYMBOL	PARAMETER	RATING	UNITS
$V_{DD}$	Supply voltage	-0.5 to +5.5	V
$P_D$	Power dissipation, $T_A = 25^\circ\text{C}$ (still air) <sup>1</sup> 8-Pin Plastic DIP 8-Pin Plastic SO	1160 780	mW mW
$T_{JMAX}$	Maximum operating junction temperature	150	$^\circ\text{C}$
$P_{MAX}$	Maximum power input/output	+20	dBm
$T_{STG}$	Storage temperature range	-65 to +150	$^\circ\text{C}$

## NOTES:

- Maximum dissipation is determined by the operating ambient temperature and the thermal resistance,  $\theta_{JA}$ :  
8-Pin DIP:  $\theta_{JA} = 108^\circ\text{C}/\text{W}$   
8-Pin SO:  $\theta_{JA} = 158^\circ\text{C}/\text{W}$

## DC ELECTRICAL CHARACTERISTICS

 $V_{DD} = +5\text{V}$ ,  $T_A = 25^\circ\text{C}$ ; unless otherwise stated.

SYMBOL	PARAMETER	TEST CONDITIONS	LIMITS			UNITS
			NE/SA630			
			MIN	TYP	MAX	
$I_{DD}$	Supply current		40	170	300	$\mu\text{A}$
$V_T$	TTL/CMOS logic threshold voltage <sup>1</sup>		1.1	1.25	1.4	V
$V_{IH}$	Logic 1 level	Enable channel 1	2.0		$V_{DD}$	V
$V_{IL}$	Logic 0 level	Enable channel 2	-0.3		0.8	V
$I_{IL}$	ENCH1 input current	ENCH1 = 0.4V	-1	0	1	$\mu\text{A}$
$I_{IH}$	ENCH1 input current	ENCH1 = 2.4V	-1	0	1	$\mu\text{A}$

## NOTE:

- The ENCH1 input must be connected to a valid Logic Level for proper operation of the NE/SA630.

## Single pole double throw (SPDT) switch

NE/SA630

AC ELECTRICAL CHARACTERISTICS<sup>1</sup> - D PACKAGE $V_{DD} = +5V$ ,  $T_A = 25^{\circ}C$ ; unless otherwise stated.

SYMBOL	PARAMETER	TEST CONDITIONS	LIMITS			UNITS
			NE/SA630			
			MIN	TYP	MAX	
$S_{21}$ , $S_{12}$	Insertion loss (ON channel)	DC - 100MHz 500MHz 900MHz		1 1.4 2	2.8	dB
$S_{21}$ , $S_{12}$	Isolation (OFF channel) <sup>2</sup>	10MHz 100MHz 500MHz 900MHz	70  24	80 60 50 30		dB
$S_{11}$ , $S_{22}$	Return loss (ON channel)	DC - 400MHz 900MHz		20 12		dB
$S_{11}$ , $S_{22}$	Return loss (OFF channel)	DC - 400MHz 900MHz		17 13		dB
$t_D$	Switching speed (on-off delay)	50% TTL to 90/10% RF		20		ns
$t_r$ , $t_f$	Switching speeds (on-off rise/fall time)	90%/10% to 10%/90% RF		5		ns
	Switching transients			165		mV <sub>P-P</sub>
$P_{-1dB}$	1dB gain compression	DC - 1GHz		+18		dBm
$IP_3$	Third-order intermodulation intercept	100MHz		+33		dBm
$IP_2$	Second-order intermodulation intercept	100MHz		+52		dBm
NF	Noise figure ( $Z_O = 50\Omega$ )	100MHz 900MHz		1.0 2.0		dB

## NOTE:

- All measurements include the effects of the D package NE/SA630 Evaluation Board (see Figure 4B). Measurement system impedance is 50 $\Omega$ .
- The placement of the AC bypass capacitor is critical to achieve these specifications. See the applications section for more details.

AC ELECTRICAL CHARACTERISTICS<sup>1</sup> - N PACKAGE $V_{DD} = +5V$ ,  $T_A = 25^{\circ}C$ ; all other characteristics similar to the D-Package, unless otherwise stated.

SYMBOL	PARAMETER	TEST CONDITIONS	LIMITS			UNITS
			NE/SA630			
			MIN	TYP	MAX	
$S_{21}$ , $S_{12}$	Insertion loss (ON channel)	DC - 100MHz 500MHz 900MHz		1 1.4 2.5		dB
$S_{21}$ , $S_{12}$	Isolation (OFF channel)	10MHz 100MHz 500MHz 900MHz	58	68 50 37 15		dB
NF	Noise figure ( $Z_O = 50\Omega$ )	100MHz 900MHz		1.0 2.5		dB

## NOTE:

- All measurements include the effects of the N package NE/SA630 Evaluation Board (see Figure 4C). Measurement system impedance is 50 $\Omega$ .

## APPLICATIONS

The typical applications schematic and printed circuit board layout of the NE/SA630 evaluation board is shown in Figure 4. The layout of the board is simple, but a few cautions need to be observed. The input and output traces should be 50 $\Omega$ . The placement of the AC bypass capacitor is *extremely critical* if a symmetric isolation between the two channels is desired. The trace from Pin 7 should be drawn back towards the package and then be routed downwards.

The capacitor should be placed straight down as close to the device as practical. For better isolation between the two channels at higher frequencies, it is also advisable to run the two output/input traces at an angle. This also minimizes any inductive coupling between the two traces. The power supply bypass capacitor should be placed close to the device. Figure 10 shows the frequency response of the NE/SA630. The loss matching between the two channels is excellent to 1.2GHz as shown in Figure 13.

# Single pole double throw (SPDT) switch

NE/SA630

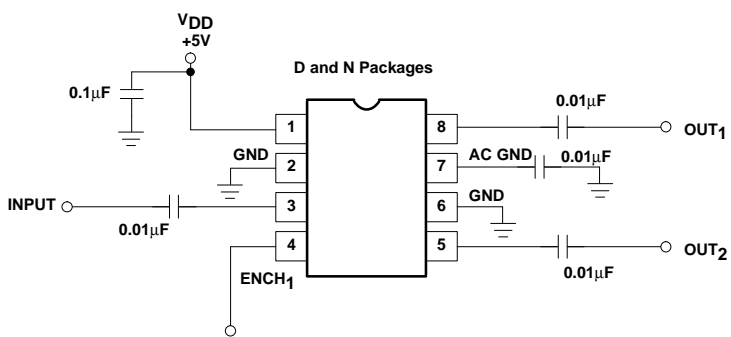

a. NE/SA Evaluation Board Schematic

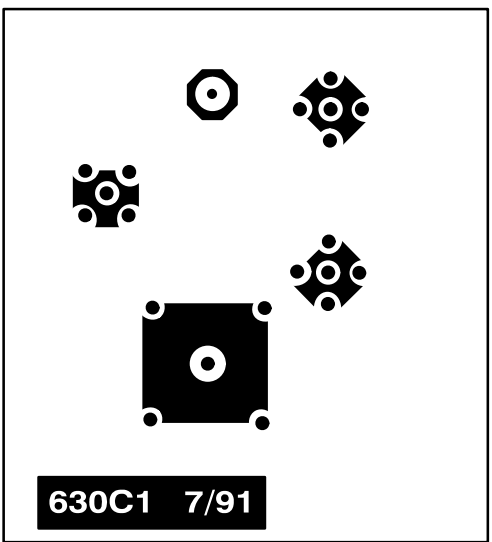
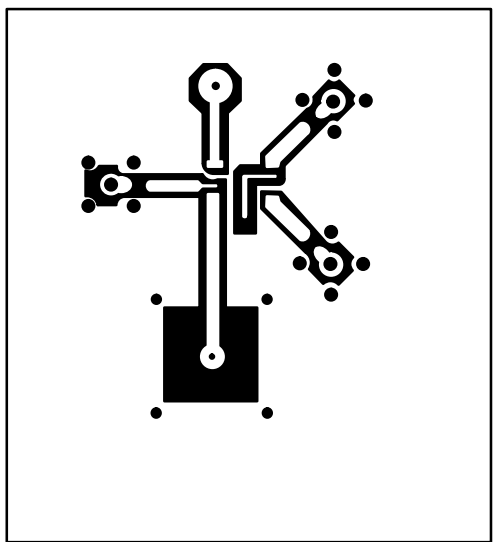

b. NE/SA630 D-Package Board Layout

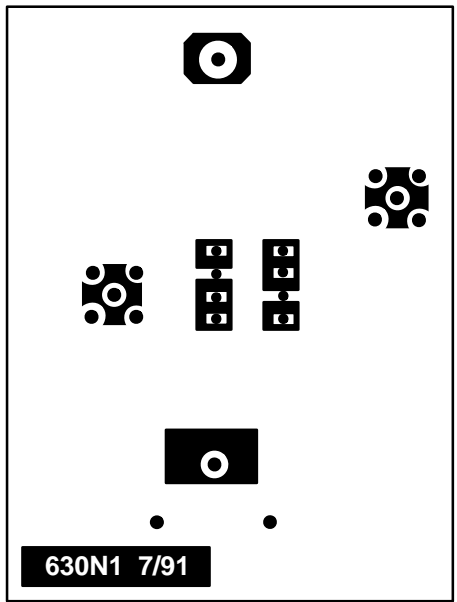
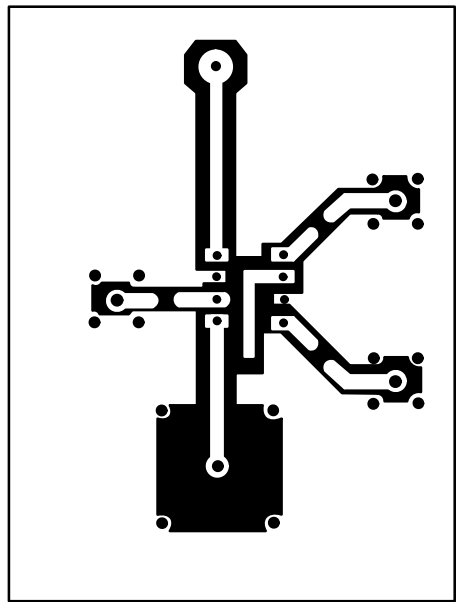

c. NE/SA630 N-Package Board Layout

SR00581

Figure 4. Board and Package Graphics

# Single pole double throw (SPDT) switch

NE/SA630

The isolation and matching of the two channels over frequency is shown in Figures 15 and 17, respectively.

The NE630 is a very versatile part and can be used in many applications. Figure 5 shows a block diagram of a typical Digital RF transceiver front-end. In this application the NE630 replaces the duplexer which is typically very bulky and lossy. Due to the low power consumption of the device, it is ideally suited for handheld applications such as in CT2 cordless telephones. The NE630 can also be used to generate Amplitude Shift Keying (ASK) or On-Off Keying (OOK) and Frequency Shift Keying (FSK) signals for digital RF communications systems. Block diagrams for these applications are shown in Figures 6 and 7, respectively.

For applications that require a higher isolation at 1GHz than obtained from a single NE630, several NE630s can be cascaded as

shown in Figure 8. The cascaded configuration will have a higher loss but greater than 35dB of isolation at 1GHz and greater than 65dB @ 500MHz can be obtained from this configuration. By modifying the enable control, an RF multiplexer/ de-multiplexer or antenna selector can be constructed. The simplicity of NE630 coupled with its ease of use and high performance lends itself to many innovative applications.

The NE/SA630 switch terminates the OFF channel in 50Ω. The 50Ω resistor is internal and is in series with the external AC bypass capacitor. Matching to impedances other than 50Ω can be achieved by adding a resistor in series with the AC bypass capacitor (e.g., 25Ω additional to match to a 75Ω environment).

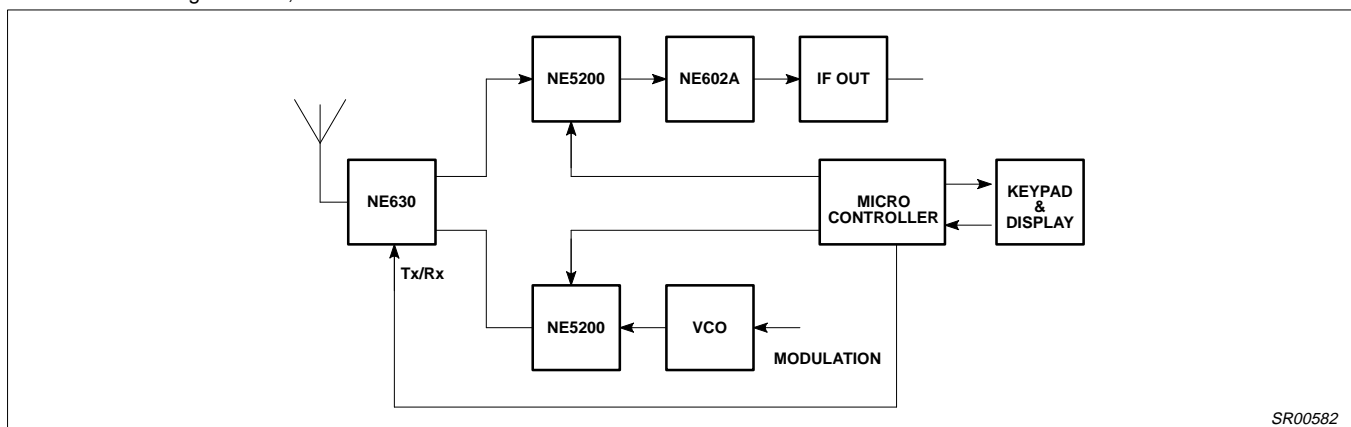

Figure 5. A Typical TDMA/Digital RF Transceiver System Front-End

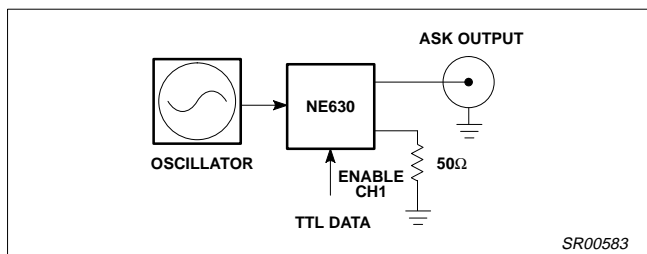

Figure 6. Amplitude Shift Keying (ASK) Generator

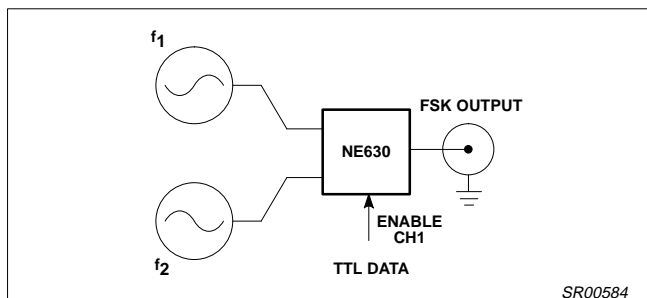

Figure 7. Frequency Shift Keying (FSK) Generator

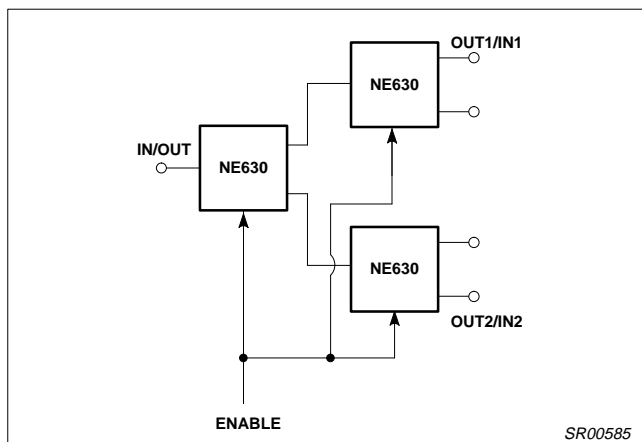

Figure 8.

# Single pole double throw (SPDT) switch

## NE/SA630

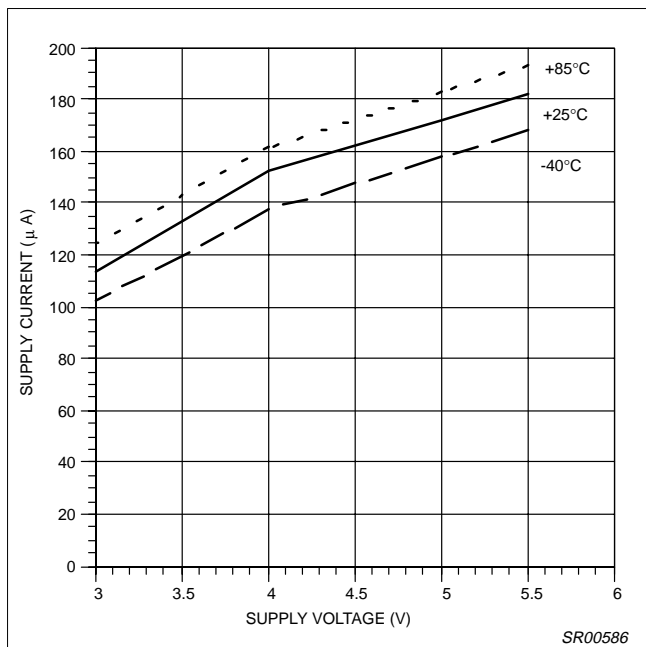

Figure 9. Supply Current vs.  $V_{DD}$  and Temperature

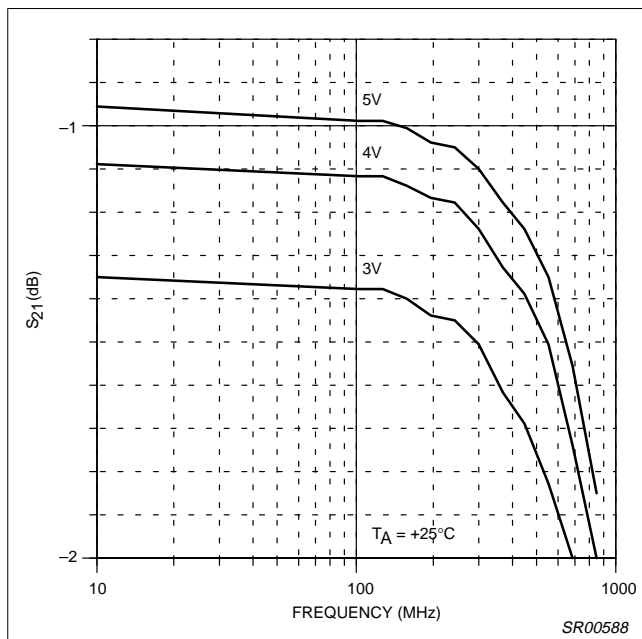

Figure 11. Loss vs. Frequency and  $V_{DD}$  for D-Package-Expanded Detail-

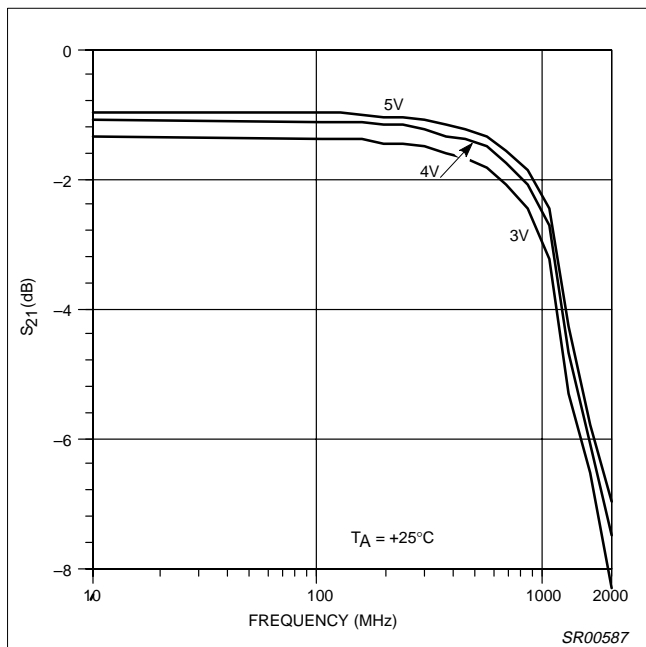

Figure 10. Loss vs. Frequency and  $V_{DD}$  for D-Package

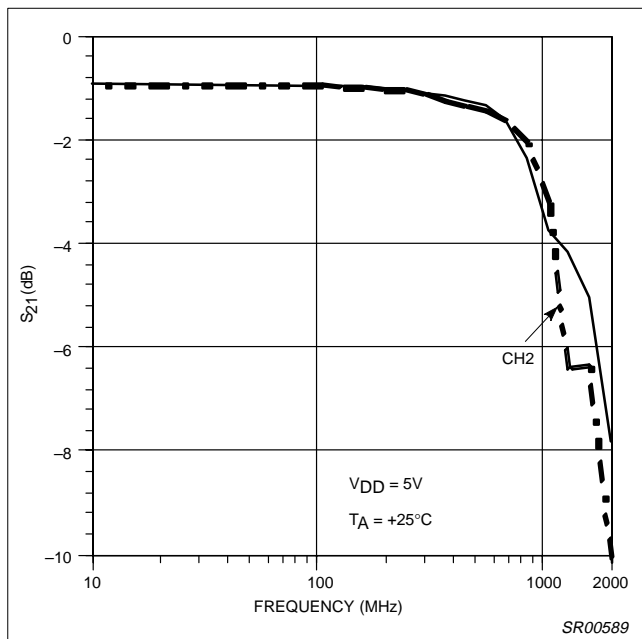

Figure 12. Loss Matching vs. Frequency for N-Package (DIP)

# Single pole double throw (SPDT) switch

## NE/SA630

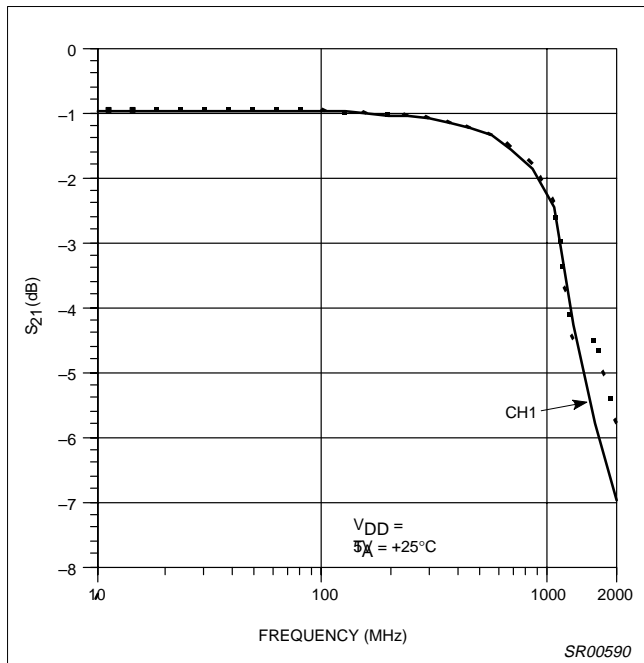

Figure 13. Loss Matching vs. Frequency; CH1 vs. CH2 for D-Package

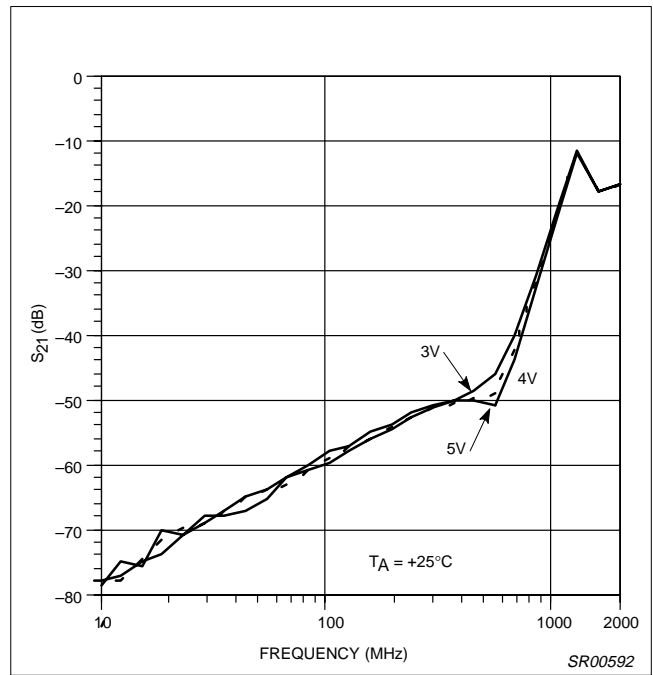

Figure 15. Isolation vs. Frequency and V<sub>DD</sub> for D-Package

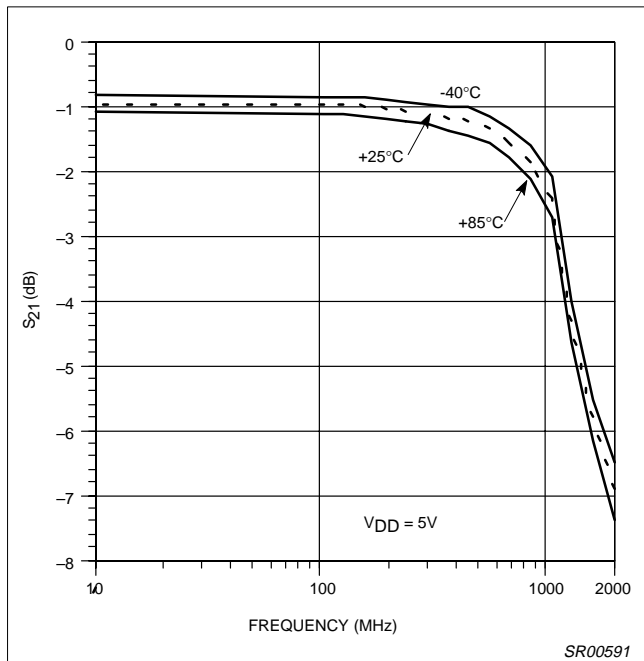

Figure 14. Loss vs. Frequency and Temperature for D-Package

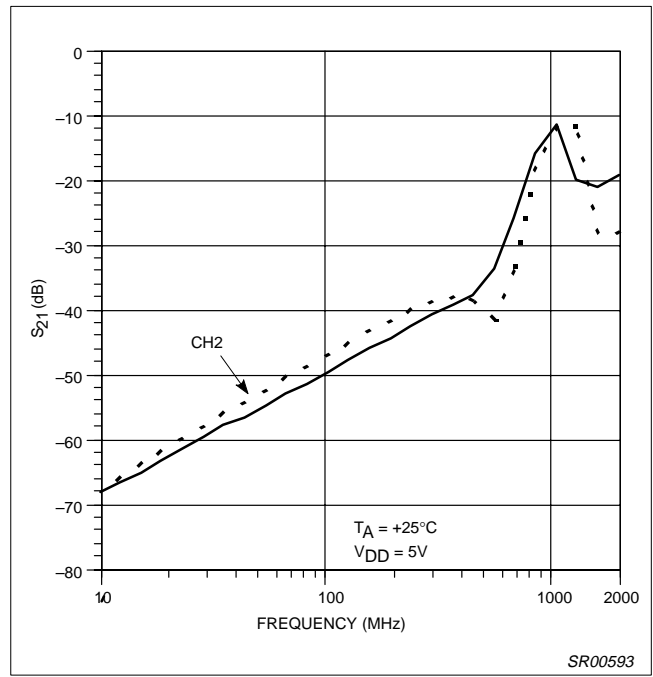

Figure 16. Isolation Matching vs. Frequency for N-Package (DIP)

# Single pole double throw (SPDT) switch

NE/SA630

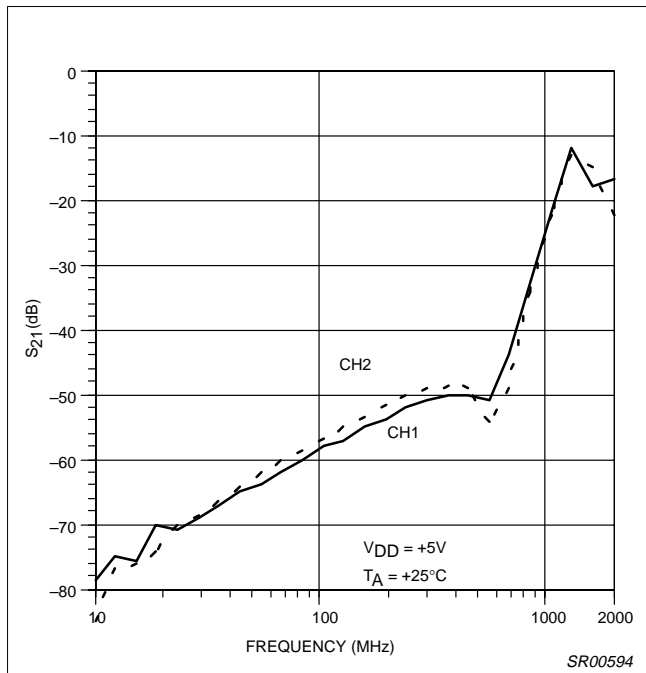

Figure 17. Isolation Matching vs. Frequency; CH1 vs. CH2 for D-Package

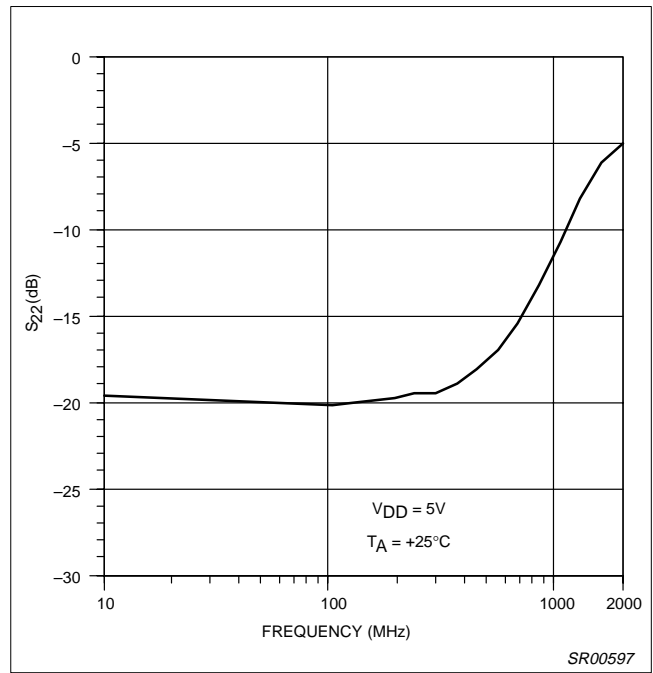

Figure 19. Output Match On-Channel vs. Frequency

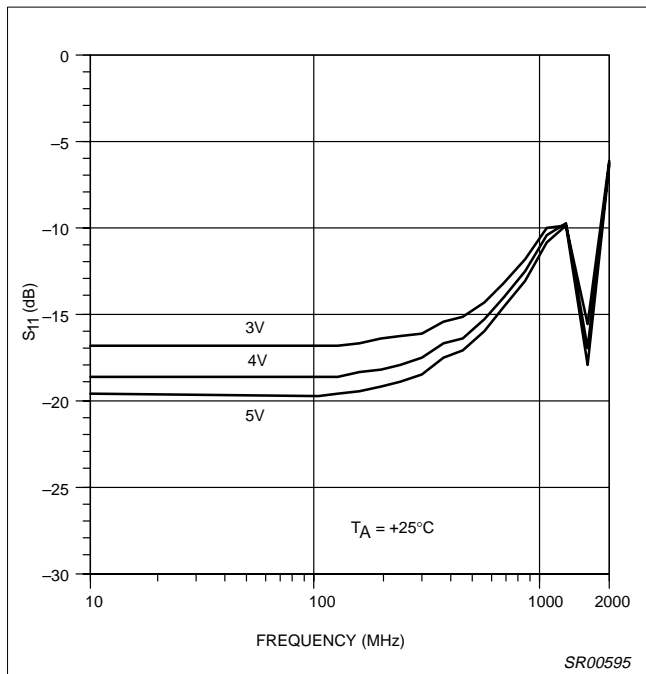

Figure 18. Input Match On-Channel vs. Frequency and VDD

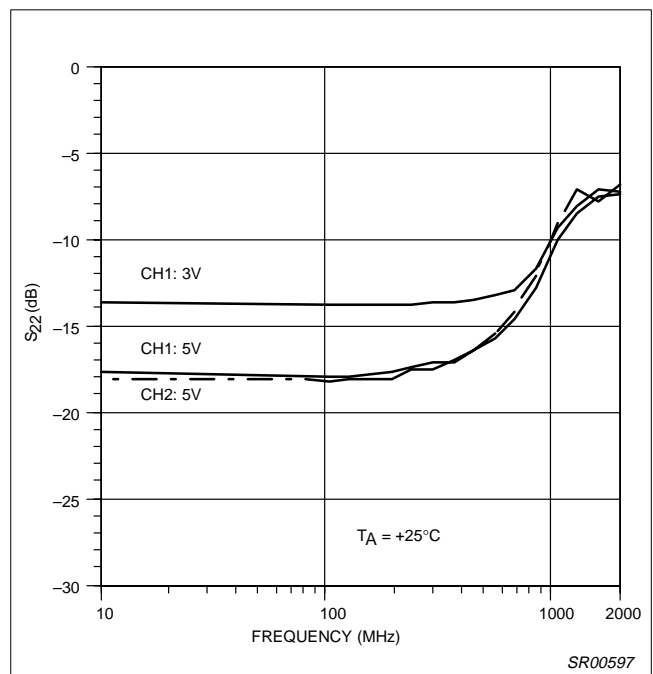
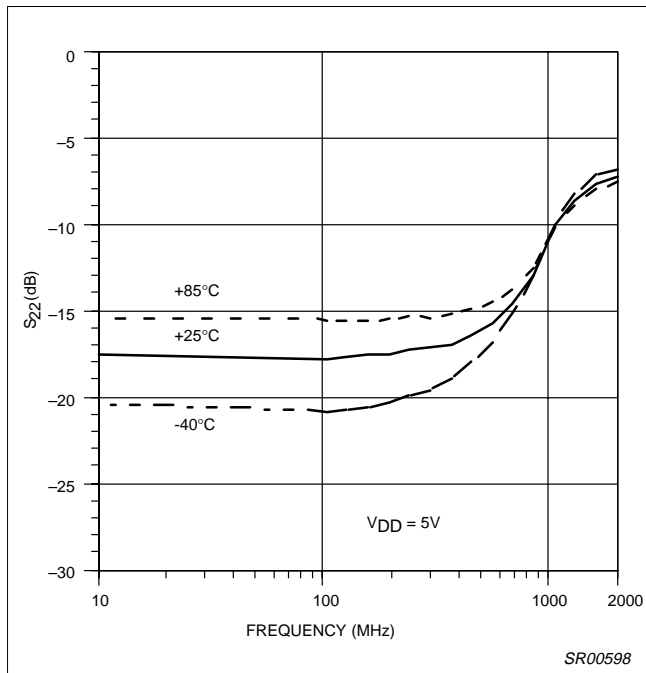

Figure 20. OFF-Channel Match vs. Frequency and VDD



# Single pole double throw (SPDT) switch

NE/SA630



**Figure 21. OFF Channel Match vs. Frequency and Temperature**

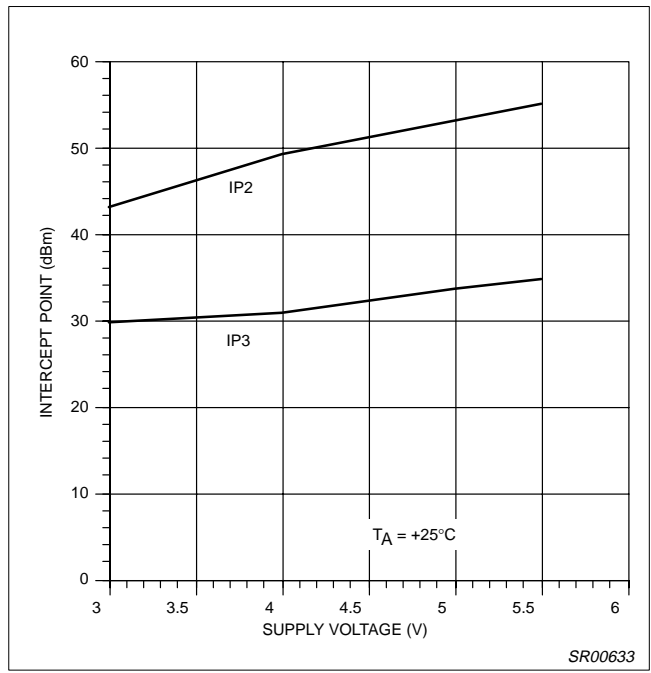

**Figure 23. Intercept Points vs. V<sub>DD</sub>**

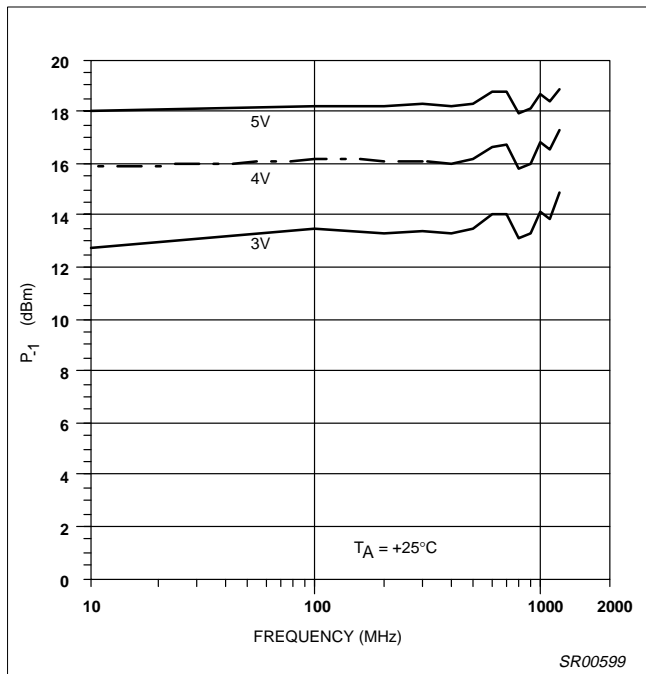

**Figure 22. P<sub>-1</sub> dB vs. Frequency and V<sub>DD</sub>**

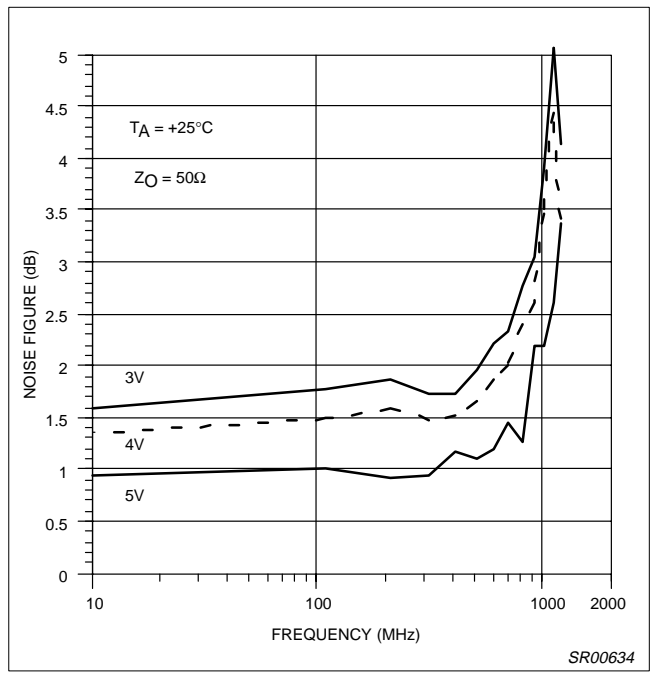

**Figure 24. Noise Figure vs. Frequency and V<sub>DD</sub> for D-Package**

# Single pole double throw (SPDT) switch

NE/SA630

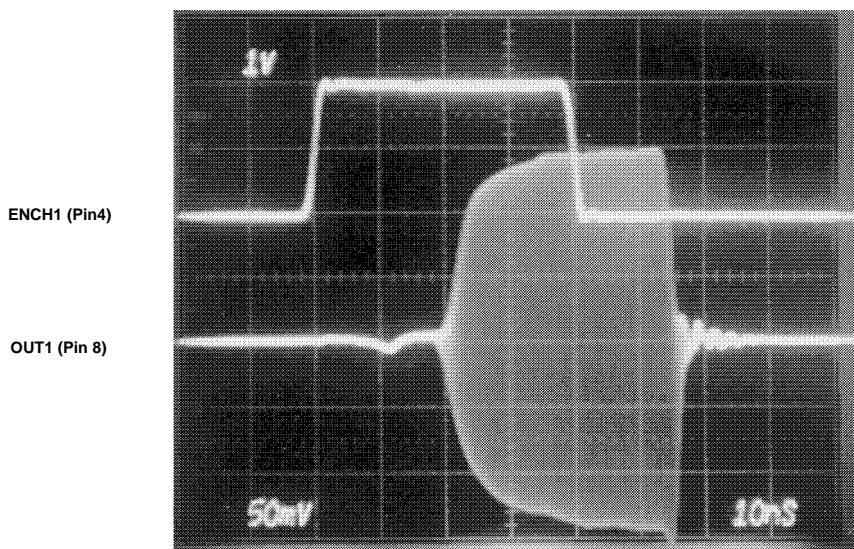

SR00635

Figure 25. Switching Speed;  $f_{IN} = 100\text{MHz}$  at  $-6\text{dBm}$ ,  $V_{DD} = 5\text{V}$