

# PTF 10136

## 6 Watts, 1.0 GHz

### GOLDMOS Field Effect Transistor

#### Description

The PTF 10136 is a 6-watt GOLDMOS FET intended for large signal amplifier applications from to 1.0 GHz. It operates at 57% efficiency with 19 dB typical gain. Nitride surface passivation and full gold metallization ensure excellent device lifetime and reliability.

- Performance at 960 MHz, 28 Volts
  - Output Power = 6 Watts
  - Efficiency = 57% Typ
  - Power Gain = 19 dB Typ
- Full Gold Metallization
- Silicon Nitride Passivated
- Surface Mountable
- Available in Tape and Reel
- 100% Lot Traceability

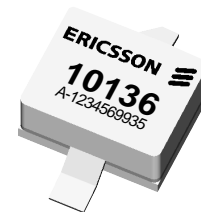
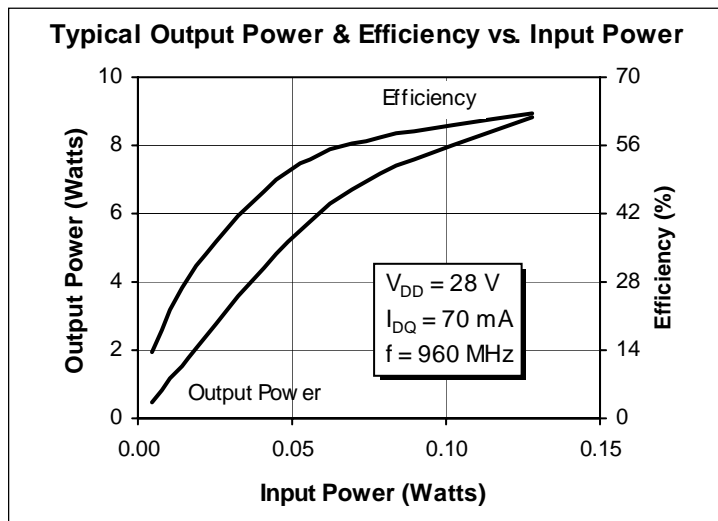

Package 20244

#### RF Specifications (100% Tested)

Characteristic	Symbol	Min	Typ	Max	Units
<b>Common Source Power Gain</b> ( $V_{DD} = 28\text{ V}$ , $P_{OUT} = 1\text{ W}$ , $I_{DQ} = 70\text{ mA}$ , $f = 960\text{ MHz}$ )	$G_{ps}$	18	19	—	dB
<b>Power Output at 1 dB Compressed</b> ( $V_{DD} = 28\text{ V}$ , $I_{DQ} = 70\text{ mA}$ , $f = 960\text{ MHz}$ )	P-1dB	6.0	7.5	—	Watts
<b>Drain Efficiency</b> ( $V_{DD} = 28\text{ V}$ , $P_{OUT} = 6\text{ W}$ , $I_{DQ} = 70\text{ mA}$ , $f = 960\text{ MHz}$ )	$\eta$	50	57	—	%
<b>Load Mismatch Tolerance</b> ( $V_{DD} = 28\text{ V}$ , $P_{OUT} = 6\text{ W}$ , $I_{DQ} = 70\text{ mA}$ , $f = 960\text{ MHz}$ — all phase angles at frequency of test)	$\Psi$	—	—	10:1	—

All published data at  $T_{CASE} = 25^\circ\text{C}$  unless otherwise indicated.

## Electrical Characteristics (100% Tested)

Characteristic	Conditions	Symbol	Min	Typ	Max	Units
Drain-Source Breakdown Voltage	$V_{GS} = 0\text{ V}, I_D = 25\text{ mA}$	$V_{(BR)DSS}$	65	—	—	Volts
Drain-Source Leakage Current	$V_{DS} = 28\text{ V}, V_{GS} = 0\text{ V}$	$I_{DSS}$	—	—	1	mA
Gate Threshold Voltage	$V_{DS} = 10\text{ V}, I_D = 75\text{ mA}$	$V_{GS(th)}$	3.0	—	5.0	Volts
Forward Transconductance	$V_{DS} = 10\text{ V}, I_D = 0.5\text{ A}$	$g_{fs}$	—	0.3	—	Siemens

## Maximum Ratings

Parameter	Symbol	Value	Unit
Drain-Source Voltage	$V_{DSS}$	65	Vdc
Gate-Source Voltage	$V_{GS}$	$\pm 20$	Vdc
Operating Junction Temperature	$T_J$	200	$^{\circ}\text{C}$
Total Device Dissipation Above 25 $^{\circ}\text{C}$ derate by	$P_D$	39 0.22	Watts $\text{W}/^{\circ}\text{C}$
Storage Temperature Range	$T_{STG}$	-40 to +150	$^{\circ}\text{C}$
Thermal Resistance ( $T_{CASE} = 70^{\circ}\text{C}$ )	$R_{\theta JC}$	4.5	$^{\circ}\text{C}/\text{W}$

## Typical Performance

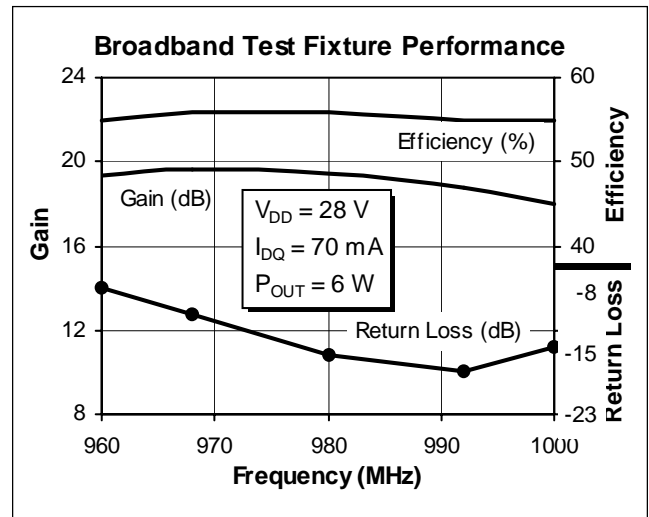
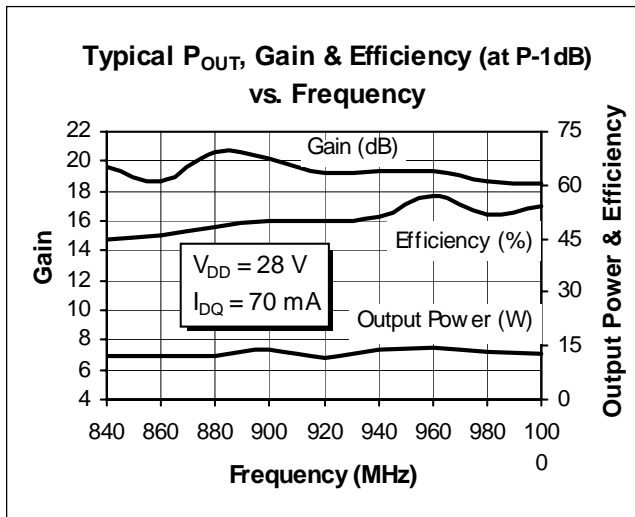

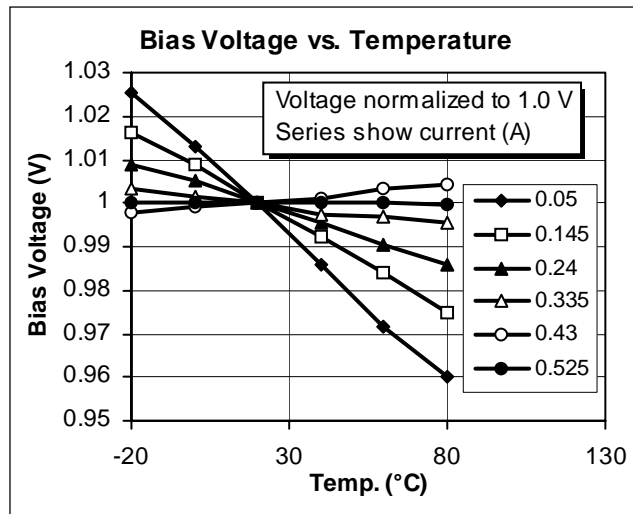
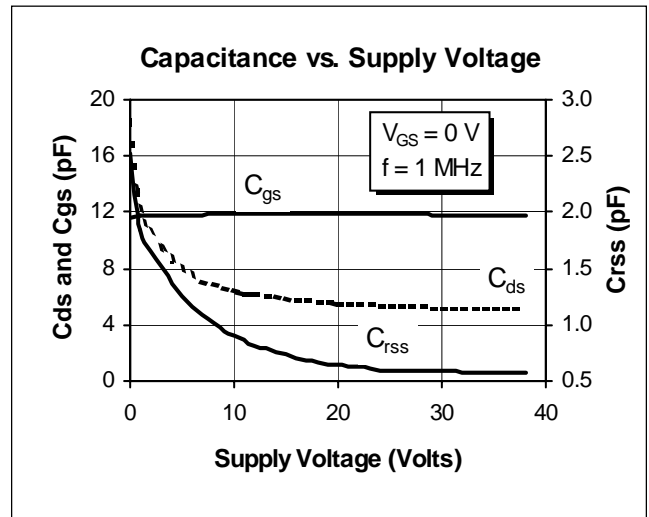
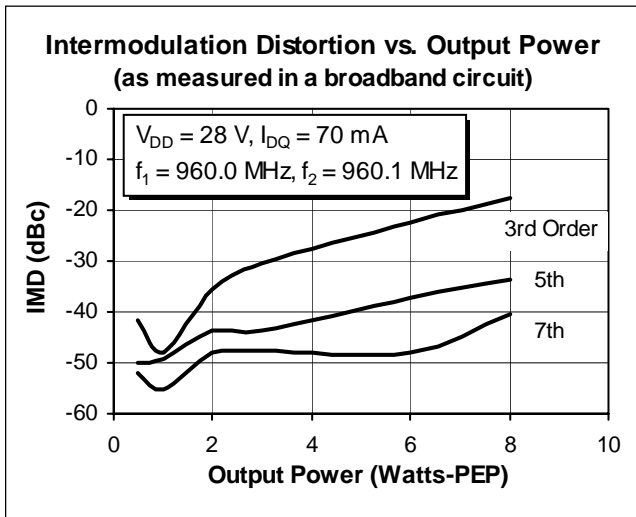
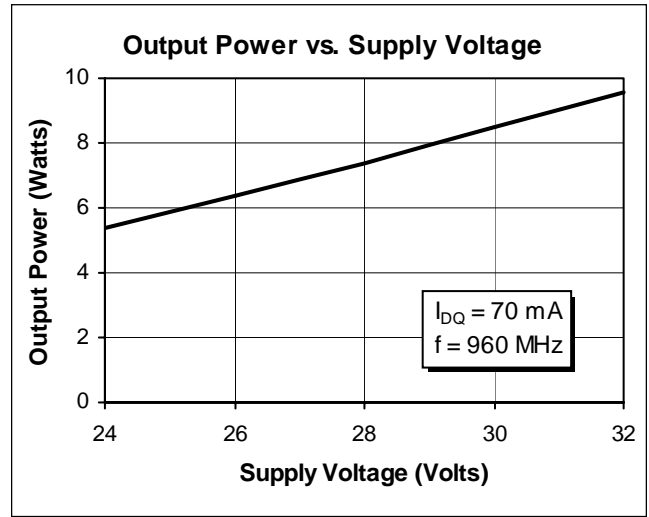
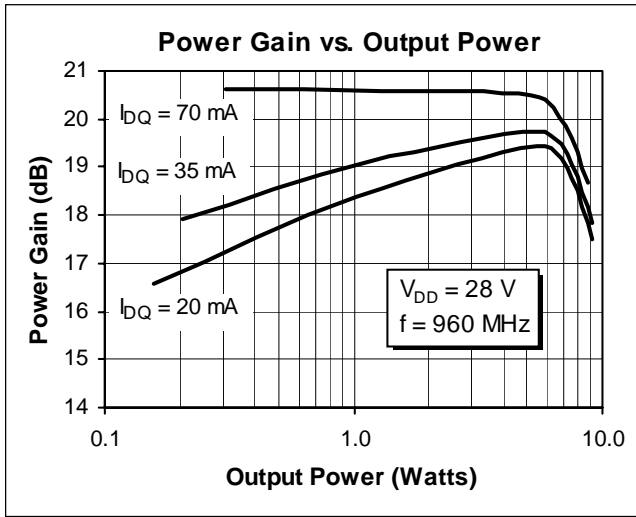

# PTF 10136

## Impedance Data

$V_{DD} = 28\text{ V}$ ,  $I_{DQ} = 70\text{ mA}$ ,  $P_{-1\text{dB}} = 6\text{ W}$

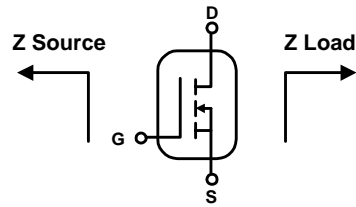

Frequency MHz	Z Source $\Omega$		Z Load $\Omega$	
	R	$jX$	R	$jX$
840	1.6	7.2	8.9	15.0
860	1.4	7.1	9.2	13.1
880	1.4	7.1	9.7	12.6
900	1.3	6.9	9.6	12.5
920	1.2	6.8	10.4	11.9
940	1.2	5.7	10.6	11.7
960	1.3	5.5	14.3	11.1
980	1.4	5.1	14.4	11.2
1000	1.7	4.9	16.3	11.1

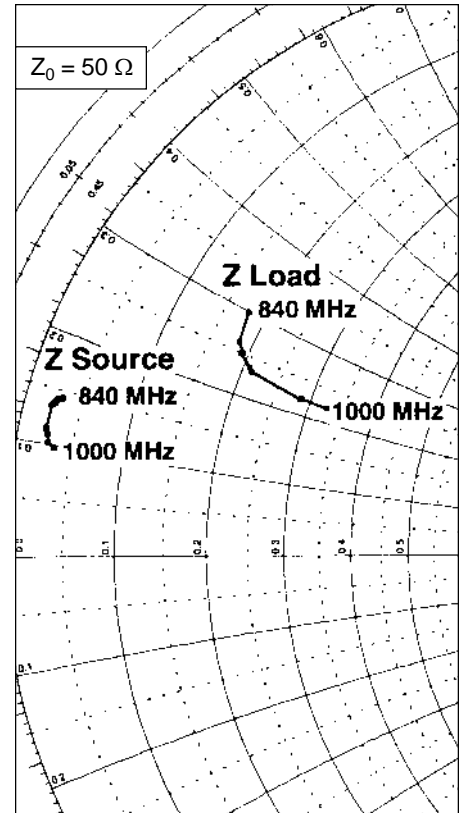

**Typical Scattering Parameters**
**(V<sub>DS</sub> = 28 V, I<sub>D</sub> = 200 mA)**

f (MHz)	S11		S21		S12		S22	
	Mag	Ang	Mag	Ang	Mag	Ang	Mag	Ang
100	0.962	-65.3	22.2	138	0.016	48.1	0.888	-31.8
150	0.925	-78.2	20.0	129	0.018	39.0	0.853	-37.7
200	0.918	-95.7	17.4	116	0.021	28.5	0.810	-46.7
250	0.913	-109	15.0	106	0.022	19.7	0.776	-54.3
300	0.906	-120	13.0	96.8	0.023	12.4	0.754	-61.2
350	0.900	-128	11.4	89.2	0.023	6.10	0.742	-67.1
400	0.896	-134	9.98	82.5	0.022	0.77	0.737	-72.9
450	0.894	-140	8.84	76.4	0.022	-3.81	0.735	-78.3
500	0.895	-144	7.90	70.9	0.021	-7.93	0.739	-83.4
550	0.896	-148	7.09	65.9	0.020	-11.6	0.743	-88.4
600	0.897	-152	6.41	61.1	0.019	-15.0	0.752	-93.2
650	0.901	-155	5.85	56.9	0.018	-17.5	0.763	-97.5
700	0.900	-158	5.33	52.7	0.017	-19.8	0.771	-102
750	0.905	-160	4.89	48.7	0.015	-21.4	0.782	-106
800	0.908	-162	4.49	45.0	0.014	-22.9	0.787	-110
850	0.910	-165	4.14	41.2	0.013	-24.2	0.797	-113
900	0.917	-167	3.85	37.8	0.012	-24.3	0.808	-117
950	0.916	-169	3.56	34.6	0.011	-24.3	0.817	-120
1000	0.919	-171	3.31	31.2	0.009	-22.7	0.828	-123
1050	0.923	-172	3.09	28.4	0.008	-20.5	0.833	-126
1100	0.925	-174	2.88	25.2	0.007	-16.5	0.841	-129
1150	0.932	-176	2.70	22.4	0.006	-10.7	0.849	-132
1200	0.929	-177	2.53	19.7	0.006	-1.76	0.855	-135
1250	0.930	-179	2.38	16.8	0.005	9.41	0.864	-138
1300	0.934	180	2.24	14.5	0.005	22.3	0.871	-140
1350	0.935	178	2.10	11.9	0.005	33.2	0.875	-142
1400	0.943	177	2.00	9.38	0.005	43.6	0.883	-145
1450	0.942	176	1.89	7.16	0.006	52.3	0.883	-147
1500	0.942	174	1.80	4.51	0.007	59.0	0.891	-149
1550	0.946	173	1.71	2.46	0.008	64.1	0.897	-151
1600	0.943	171	1.62	-0.02	0.009	67.2	0.902	-153
1650	0.951	170	1.55	-2.40	0.010	69.7	0.911	-155
1700	0.951	169	1.48	-4.21	0.011	71.9	0.911	-157
1750	0.951	167	1.41	-6.51	0.012	72.2	0.911	-159
1800	0.952	166	1.35	-8.48	0.013	72.5	0.912	-161
1850	0.947	165	1.28	-10.8	0.014	72.0	0.911	-163
1900	0.951	163	1.24	-13.0	0.015	71.8	0.920	-165
1950	0.951	162	1.18	-14.7	0.017	71.9	0.920	-166
2000	0.949	161	1.13	-16.8	0.018	71.3	0.923	-168
2050	0.953	160	1.09	-18.7	0.019	71.1	0.925	-170
2100	0.947	159	1.05	-20.8	0.020	70.4	0.922	-171
2150	0.950	157	1.01	-22.9	0.021	69.4	0.929	-173
2200	0.946	156	0.982	-24.2	0.022	68.6	0.930	-175

# PTF 10136

## Test Circuit

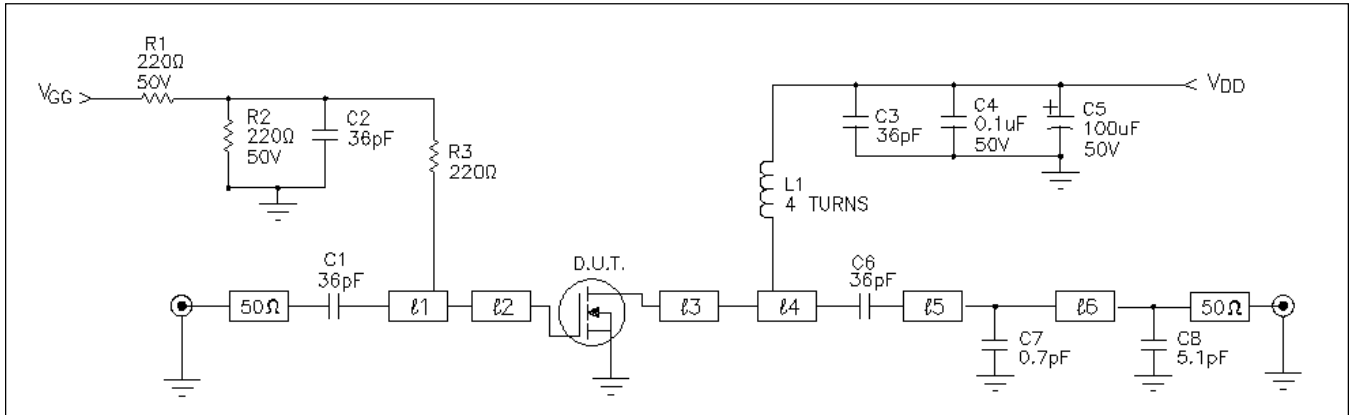

Test Circuit Schematic for  $f=960$  MHz

DUT	PTF 10136	LDMOS Transistor	C1, C2, C3, C6	36 pF, Capacitor ATC 100 B
l1	0.221 $\lambda$ 960 MHz	Microstrip 8.9 $\Omega$	C4	0.1 $\mu$ F, 50 V, Capacitor Digi-Key P4525-ND
l2, l3	0.020 $\lambda$ 960 MHz	Microstrip 41.0 $\Omega$	C5	100 $\mu$ F, 50 V, Capacitor, Digi-Key P5782-ND
l4	0.190 $\lambda$ 960 MHz	Microstrip 14.1 $\Omega$	C7	0.7 $\mu$ F ATC 100 B
l5	0.024 $\lambda$ 960 MHz	Microstrip 50 $\Omega$	C8	5.1 $\mu$ F ATC 100 B
l6	0.034 $\lambda$ 960 MHz	Microstrip 50 $\Omega$	J1, J2	Connector, SMA, Female, Panel Mount N/A
			L1	4 Turns, 22 AWG, .085 Dia I.D. Magnet Wire N/A
			R1, R2, R3	Resistor, 220ohm, 1/4W Digi-Key 2.2QBK
			Circuit Board	.031" thick, $\epsilon_r = 4.0$ , G200, AlliedSignal, 2 oz. copper

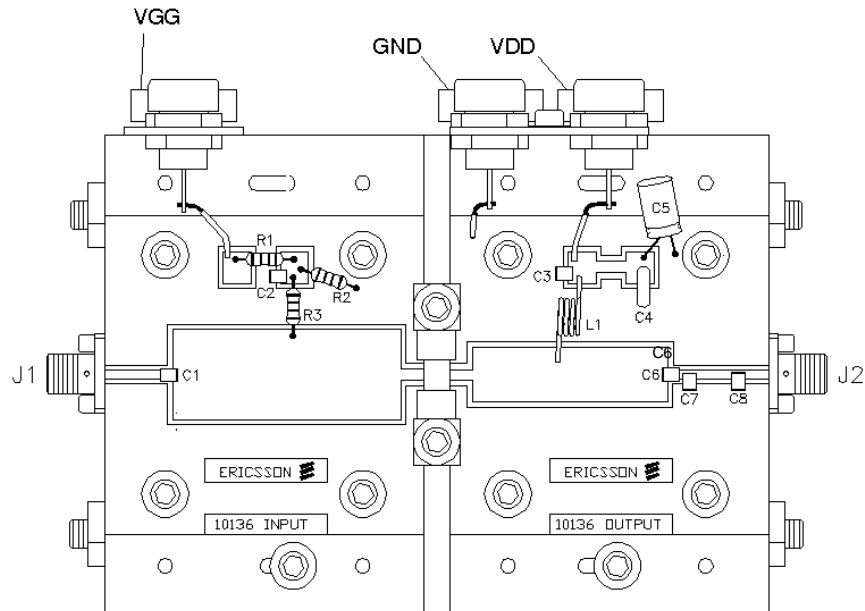

Placement Diagram (not to scale)

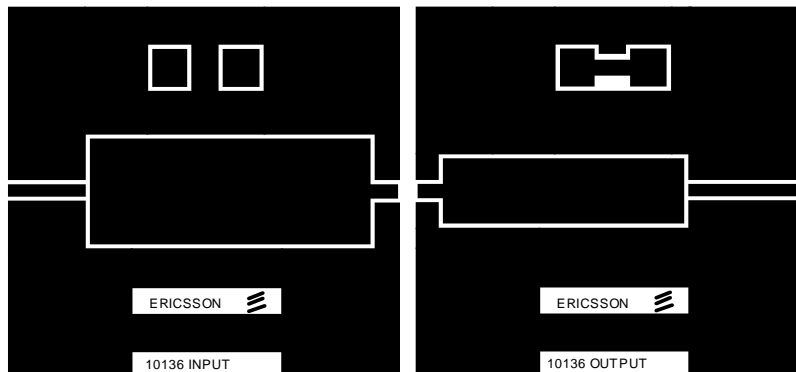

Artwork ( not to scale )

**Case Outline Specifications**

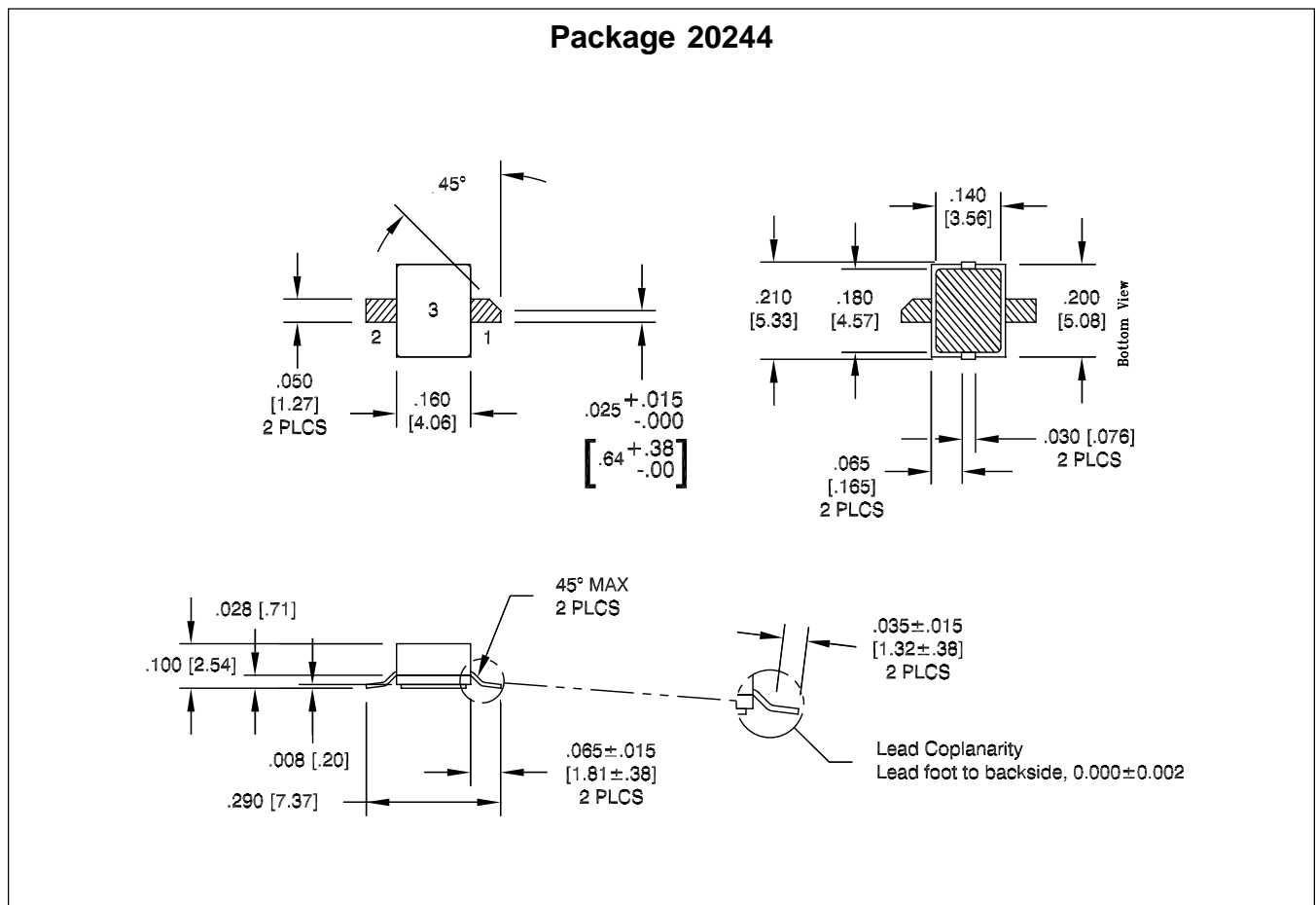

**Ericsson Inc.**  
**Microelectronics**  
 Morgan Hill, CA 95037 USA

1-877-GOLDMOS (465-3667) United States  
 +46 8 757 4700 International  
 e-mail: rfpower@ericsson.com  
 www.ericsson.com/rfpower

Specifications subject to change without notice.  
 L3  
 © 1998, 1999, 2000, 2001 Ericsson Inc.  
 EUS/KR 1522-PTF 10136 Uen Rev. B 03-15-01

This datasheet has been download from:

[www.datasheetcatalog.com](http://www.datasheetcatalog.com)

Datasheets for electronics components.