

Low-voltage high performance mixer FM IF system

SA606

DESCRIPTION

The SA606 is a low-voltage high performance monolithic FM IF system incorporating a mixer/oscillator, two limiting intermediate frequency amplifiers, quadrature detector, logarithmic received signal strength indicator (RSSI), voltage regulator and audio and RSSI op amps. The SA606 is available in 20-lead dual-in-line plastic, 20-lead SOL (surface-mounted small outline large package) and 20-lead SSOP (shrink small outline package).

The SA606 was designed for portable communication applications and will function down to 2.7V. The RF section is similar to the famous NE605. The audio and RSSI outputs have amplifiers with access to the feedback path. This enables the designer to level adjust the outputs or add filtering.

FEATURES

- Low power consumption: 3.5mA typical at 3V
- Mixer input to >150MHz
- Mixer conversion power gain of 17dB at 45MHz
- XTAL oscillator effective to 150MHz (L.C. oscillator or external oscillator can be used at higher frequencies)
- 102dB of IF Amp/Limiter gain
- 2MHz limiter small signal bandwidth
- Temperature compensated logarithmic Received Signal Strength Indicator (RSSI) with a 90dB dynamic range
- Low external component count; suitable for crystal/ceramic/LC filters
- Excellent sensitivity: 0.31µV into 50Ω matching network for 12dB SINAD (Signal to Noise and Distortion ratio) for 1kHz tone with RF at 45MHz and IF at 455kHz
- SA606 meets cellular radio specifications
- Audio output internal op amp
- RSSI output internal op amp
- Internal op amps with rail-to-rail outputs

PIN CONFIGURATION

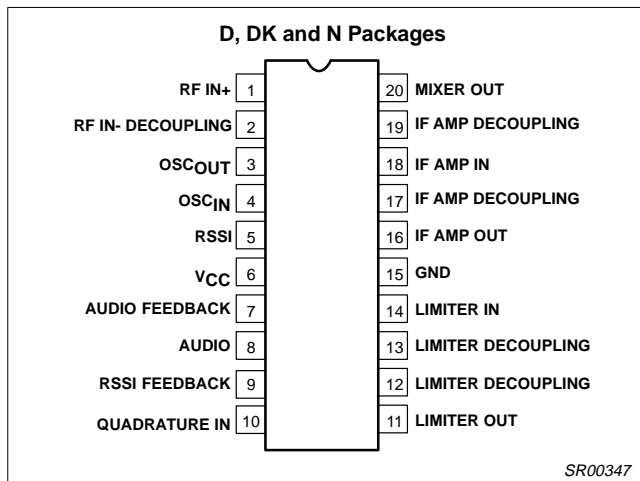

Figure 1. Pin Configuration

- ESD protection: Human Body Model 2kV
Robot Model 200V

APPLICATIONS

- Portable cellular radio FM IF
- Cordless phones
- Wireless systems
- RF level meter
- Spectrum analyzer
- Instrumentation
- FSK and ASK data receivers
- Log amps
- Portable high performance communication receiver
- Single conversion VHF receivers

ORDERING INFORMATION

DESCRIPTION	TEMPERATURE RANGE	ORDER CODE	DWG #
20-Pin Plastic Dual In-Line Package (DIP)	-40 to +85°C	SA606N	SOT146-1
20-Pin Plastic Small Outline Large (SOL) package (Surface-mount)	-40 to +85°C	SA606D	SOT163-1
20-Pin Plastic Shrink Small Outline Package (SSOP) (Surface-mount)	-40 to +85°C	SA606DK	SOT266-1

ABSOLUTE MAXIMUM RATINGS

SYMBOL	PARAMETER	RATING	UNITS
V _{CC}	Single supply voltage	7	V
T _{STG}	Storage temperature range	-65 to +150	°C
T _A	Operating ambient temperature range	-40 to +85	°C
θ _{JA}	Thermal impedance D package DK package N package	90 117 75	°C/W

Low-voltage high performance mixer FM IF system

SA606

BLOCK DIAGRAM

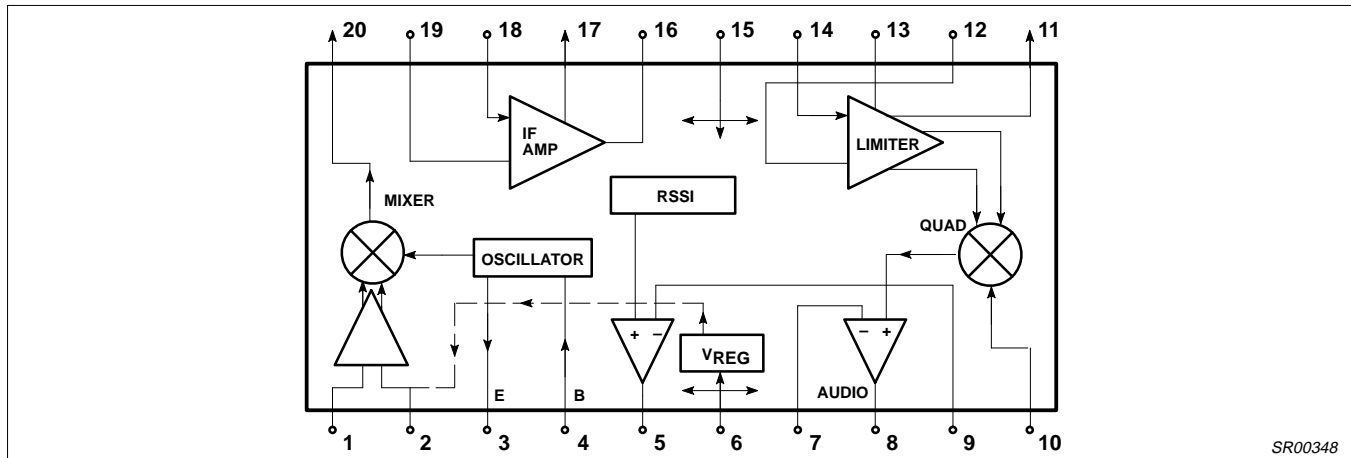

Figure 2. Block Diagram

SR00348

DC ELECTRICAL CHARACTERISTICS

$V_{CC} = +3V$, $T_A = 25^\circ C$; unless otherwise stated.

SYMBOL	PARAMETER	TEST CONDITIONS	LIMITS			UNITS
			MIN	TYP	MAX	
V_{CC}	Power supply voltage range		2.7		7.0	V
I_{CC}	DC current drain			3.5	4.2	mA

AC ELECTRICAL CHARACTERISTICS

$T_A = 25^\circ C$; $V_{CC} = +3V$, unless otherwise stated. RF frequency = 45MHz + 14.5dBV RF input step-up; IF frequency = 455kHz; $R_{17} = 2.4k\Omega$ and $R_{18} = 3.3k\Omega$; RF level = -45dBm; FM modulation = 1kHz with ± 8 kHz peak deviation. Audio output with de-emphasis filter and C-message weighted filter. Test circuit Figure 3. The parameters listed below are tested using automatic test equipment to assure consistent electrical characteristics. The limits do not represent the ultimate performance limits of the device. Use of an optimized RF layout will improve many of the listed parameters.

SYMBOL	PARAMETER	TEST CONDITIONS	LIMITS			UNITS
			MIN	TYP	MAX	
Mixer/Osc section (ext LO = 220mV_{RMS})						
f_{IN}	Input signal frequency			150		MHz
f_{OSC}	Crystal oscillator frequency			150		MHz
	Noise figure at 45MHz			6.2		dB
	Third-order input intercept point (50 Ω source)	$f_1 = 45.0$; $f_2 = 45.06$ MHz Input RF level = -52dBm		-9		dBm
	Conversion voltage gain	Matched 14.5dBV step-up	13.5	17	19.5	dB
		50 Ω source		+2.5		dB
	RF input resistance	Single-ended input		8		k Ω
	RF input capacitance			3.0	4.0	pF
	Mixer output resistance	(Pin 20)	1.25	1.5		k Ω
IF section						
	IF amp gain	50 Ω source		44		dB
	Limiter gain	50 Ω source		58		dB
	Input limiting -3dB, $R_{17a} = 2.4k$, $R_{17b} = 3.3k$	Test at Pin 18		-109		dBm
	AM rejection	80% AM 1kHz		45		dB
	Audio level	Gain of two (2k Ω AC load)	70	120	160	mV
	SINAD sensitivity	IF level -110dBm		17		dB

Low-voltage high performance mixer FM IF system

SA606

AC ELECTRICAL CHARACTERISTICS (Continued)

SYMBOL	PARAMETER	TEST CONDITIONS	LIMITS			UNITS
			MIN	TYP	MAX	
THD	Total harmonic distortion		-35	-50		dB
S/N	Signal-to-noise ratio	No modulation for noise		62		dB
	RF RSSI output, $R_g = 2k\Omega$	RF level = -118dBm		0.3	.80	V
		RF level = -68dBm	.70	1.1	1.80	V
		RF level = -23dBm	1.20	1.8	2.50	V
	RSSI range			90		dB
	RSSI accuracy			± 1.5		dB
	IF input impedance	Pin 18	1.3	1.5		k Ω
	IF output impedance	Pin 16		0.3		k Ω
	Limiter input impedance	Pin 14	1.3	1.5		k Ω
	Limiter output impedance	Pin 11		0.3		k Ω
	Limiter output voltage	Pin 11		130		mV _{RMS}
RF/IF section (int LO)						
	Audio level	$3V = V_{CC}$, RF level = -27dBm		120		mV _{RMS}
	System RSSI output	$3V = V_{CC}$, RF level = -27dBm		2.2		V
	System SINAD sensitivity	RF level = -117dBm		12		dB

CIRCUIT DESCRIPTION

The SA606 is an IF signal processing system suitable for second IF systems with input frequency as high as 150MHz. The bandwidth of the IF amplifier and limiter is at least 2MHz with 90dB of gain. The gain/bandwidth distribution is optimized for 455kHz, 1.5k Ω source applications. The overall system is well-suited to battery operation as well as high performance and high quality products of all types.

The input stage is a Gilbert cell mixer with oscillator. Typical mixer characteristics include a noise figure of 6.2dB, conversion gain of 17dB, and input third-order intercept of -9dBm. The oscillator will operate in excess of 200MHz in L/C tank configurations. Hartley or Colpitts circuits can be used up to 100MHz for xtal configurations. Butler oscillators are recommended for xtal configurations up to 150MHz.

The output impedance of the mixer is a 1.5k Ω resistor permitting direct connection to a 455kHz ceramic filter. The input resistance of the limiting IF amplifiers is also 1.5k Ω . With most 455kHz ceramic filters and many crystal filters, no impedance matching network is necessary. The IF amplifier has 43dB of gain and 5.5MHz bandwidth. The IF limiter has 60dB of gain and 4.5MHz bandwidth. To achieve optimum linearity of the log signal strength indicator, there must be a 12dB(v) insertion loss between the first and second IF stages. If the IF filter or interstage network does not cause

12dB(v) insertion loss, a fixed or variable resistor or an L pad for simultaneous loss and impedance matching can be added between the first IF output (Pin 16) and the interstage network. The overall gain will then be 90dB with 2MHz bandwidth.

The signal from the second limiting amplifier goes to a Gilbert cell quadrature detector. One port of the Gilbert cell is internally driven by the IF. The other output of the IF is AC-coupled to a tuned quadrature network. This signal, which now has a 90° phase relationship to the internal signal, drives the other port of the multiplier cell.

The demodulated output of the quadrature drives an internal op amp. This op amp can be configured as a unity gain buffer, or for simultaneous gain, filtering, and 2nd-order temperature compensation if needed. It can drive an AC load as low as 5k Ω with a rail-to-rail output.

A log signal strength completes the circuitry. The output range is greater than 90dB and is temperature compensated. This log signal strength indicator exceeds the criteria for AMPs or TACs cellular telephone. This signal drives an internal op amp. The op amp is capable of rail-to-rail output. It can be used for gain, filtering, or 2nd-order temperature compensation of the RSSI, if needed.

NOTE: $dB(v) = 20\log V_{OUT}/V_{IN}$

Low-voltage high performance mixer FM IF system

SA606

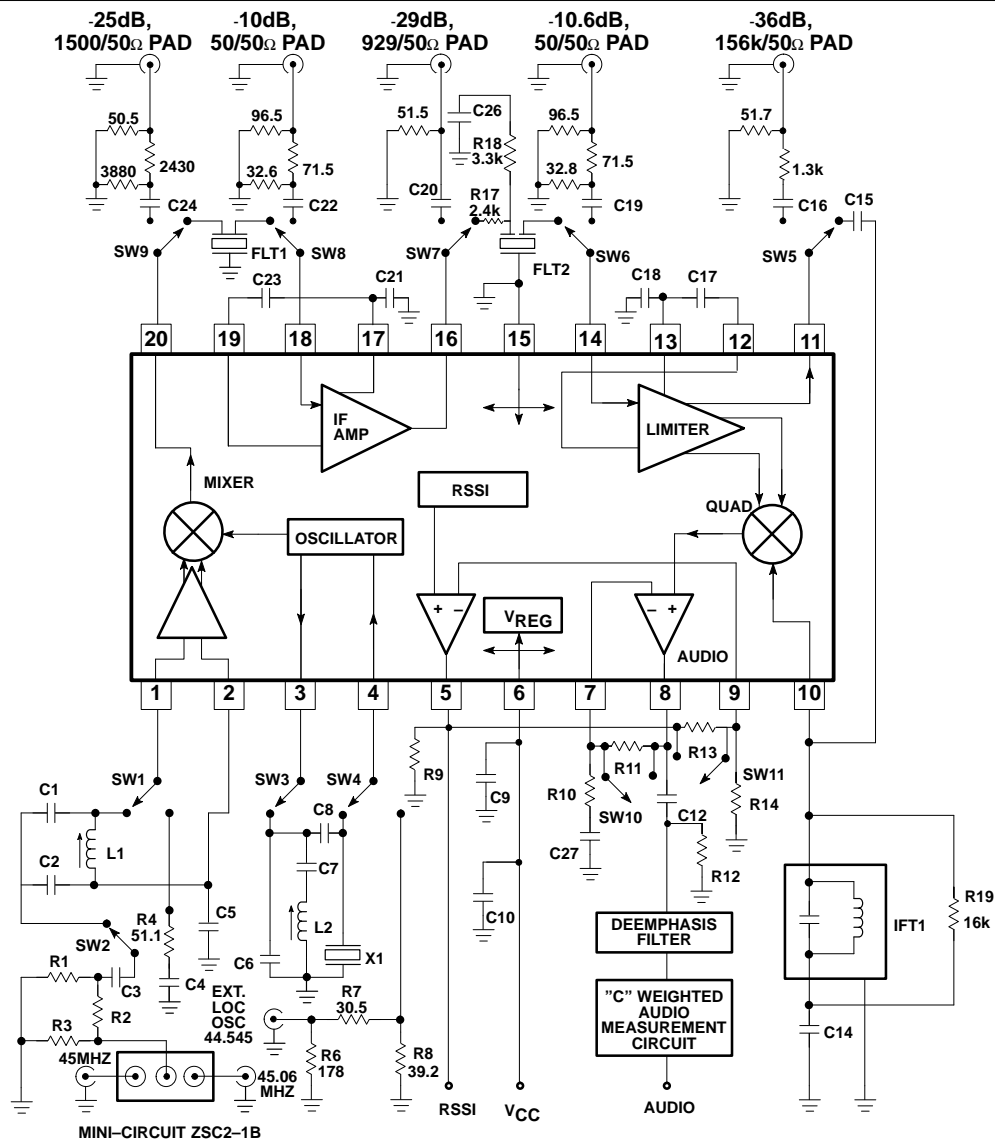

Automatic Test Circuit Component List

- | | | | |
|-----|-------------------------------|-------|---|
| C1 | 100pF NPO Ceramic | C27 | 2.2μF ±10% Monolithic Ceramic |
| C2 | 390pF NPO Ceramic | Flt 1 | Ceramic Filter Murata SFG455A3 or equiv |
| C5 | 100nF ±10% Monolithic Ceramic | Flt 2 | Ceramic Filter Murata SFG455A3 or equiv |
| C6 | 22pF NPO Ceramic | IFT 1 | 455kHz (Ce = 180pF) Toko RMC-2A6597H |
| C7 | 1nF Ceramic | L1 | 147-160nH Coilcraft UNI-10/142-04J08S |
| C8 | 10.0pF NPO Ceramic | L2 | 0.8μH nominal |
| C9 | 100nF ±10% Monolithic Ceramic | | Toko 292CNS-T1038Z |
| C10 | 10μF Tantalum (minimum) * | X1 | 44.545MHz Crystal ICM4712701 |
| C12 | 2.2μF | R9 | 2kΩ ±1% 1/4W Metal Film |
| C14 | 100nF ±10% Monolithic Ceramic | R10 | 10kΩ ±1% |
| C15 | 10pF NPO Ceramic | R11 | 10kΩ ±1% |
| C17 | 100nF ±10% Monolithic Ceramic | R12 | 2kΩ ±1% |
| C18 | 100nF ±10% Monolithic Ceramic | R13 | 20kΩ ±1% |
| C21 | 100nF ±10% Monolithic Ceramic | R14 | 10kΩ ±1% |
| C23 | 100nF ±10% Monolithic Ceramic | R17 | 2.4kΩ ±5% 1/4W Carbon Composition |
| C25 | 100nF ±10% Monolithic Ceramic | R18 | 3.3kΩ |
| C26 | 100nF ±10% Monolithic Ceramic | R19 | 16kΩ |

*NOTE: This value can be reduced when a battery is the power source.

Figure 3. SA606 45MHz Test Circuit (Relays as shown)

Low-voltage high performance mixer FM IF system

SA606

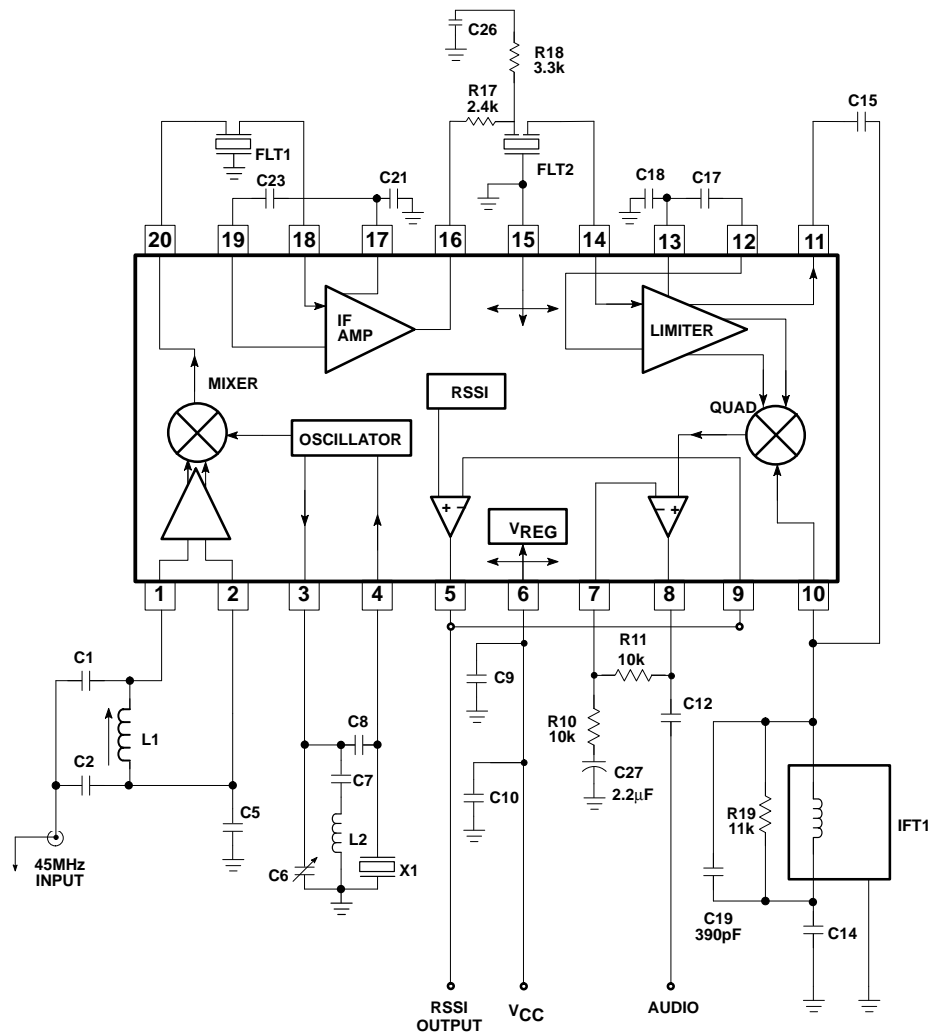

NE606D/DK Demo Board
Application Component List

C1	51pF NPO Ceramic	C23	100nF $\pm 10\%$ Monolithic Ceramic
C2	220pF NPO Ceramic	C26	100nF $\pm 10\%$ Monolithic Ceramic
C5	100nF $\pm 10\%$ Monolithic Ceramic	C27	2.2 μ F Tantalum
C6	5-30pF trim cap	Flt 1	Ceramic Filter Murata SFG455A3 or equiv
C7	1nF Ceramic	Flt 2	Ceramic Filter Murata SFG455A3 or equiv
C8	10.0pF NPO Ceramic	IFT 1	330 μ H TOKO 303LN-1130
C9	100nF $\pm 10\%$ Monolithic Ceramic	L1	.33 μ H TOKO SCB-1320Z
C10	10 μ F Tantalum (minimum) *	L2	1.2 μ H
C12	2.2 μ F $\pm 10\%$ Tantalum	X1	44.545MHz Crystal ICM4712701
C14	100nF $\pm 10\%$ Monolithic Ceramic	R5	Not Used in Application Board (see Note 8, pg 8)
C15	10pF NPO Ceramic	R10	8.2k $\pm 5\%$ 1/4W Carbon Composition
C17	100nF $\pm 10\%$ Monolithic Ceramic	R11	10k $\pm 5\%$ 1/4W Carbon Composition
C18	100nF $\pm 10\%$ Monolithic Ceramic	R17	2.4k $\pm 5\%$ 1/4W Carbon Composition
C19	390pF $\pm 10\%$ Monolithic Ceramic	R18	3.3k $\pm 5\%$ 1/4W Carbon Composition
C21	100nF $\pm 10\%$ Monolithic Ceramic	R19	11k $\pm 5\%$ 1/4W Carbon Composition

* NOTE: This value can be reduced when a battery is the power source.

SR00350

Figure 4. SA606 45MHz Application Circuit

Low-voltage high performance mixer FM IF system

SA606

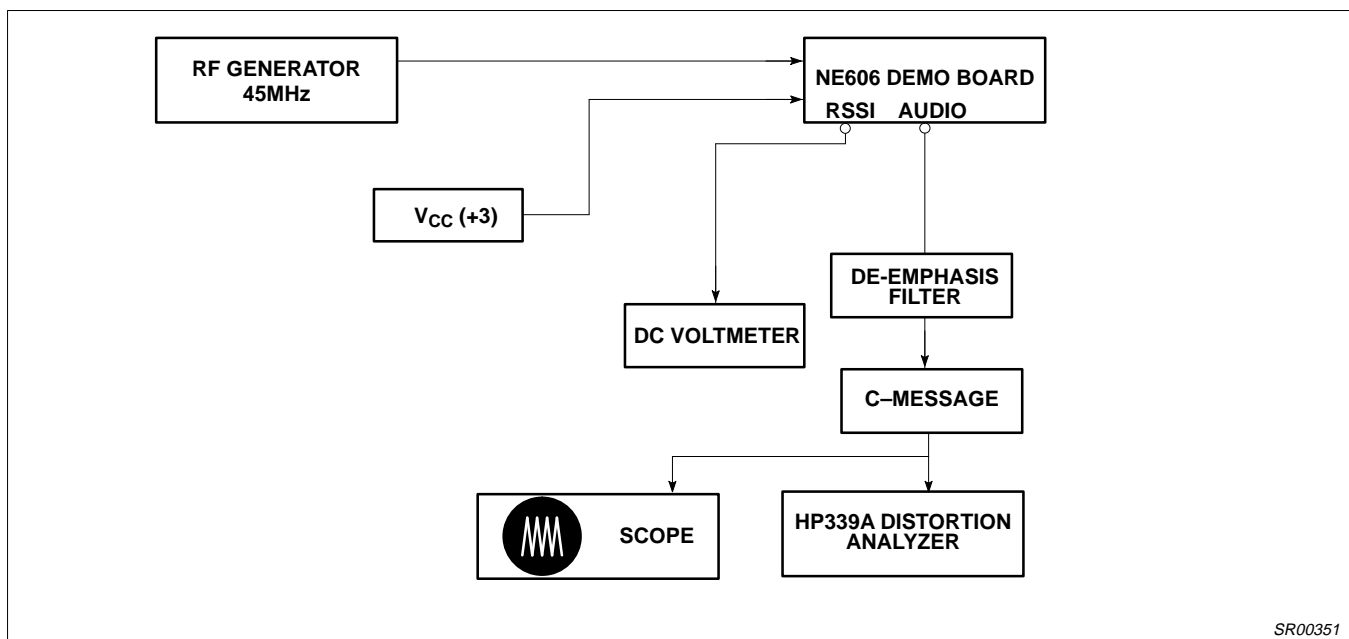

SR00351

Figure 5. SA606 Application Circuit Test Set Up

NOTES:

1. C-message: The C-message and de-emphasis filter combination has a peak gain of 10 for accurate measurements. Without the gain, the measurements may be affected by the noise of the scope and HP339 analyzer. The de-emphasis filter has a fixed -6dB/Octave slope between 300Hz and 3kHz.
2. Ceramic filters: The ceramic filters can be 30kHz SFG455A3s made by Murata which have 30kHz IF bandwidth (they come in blue), or 16kHz CFU455Ds, also made by Murata (they come in black). All of our specifications and testing are done with the more wideband filter.
3. RF generator: Set your RF generator at 45.000MHz, use a 1kHz modulation frequency and a 6kHz deviation if you use 16kHz filters, or 8kHz if you use 30kHz filters.
4. Sensitivity: The measured typical sensitivity for 12dB SINAD should be 0.35 μ V or -116dBm at the RF input.
5. Layout: The layout is very critical in the performance of the receiver. We highly recommend our demo board layout.
6. RSSI: The smallest RSSI voltage (i.e., when no RF input is present and the input is terminated) is a measure of the quality of the layout and design. If the lowest RSSI voltage is 500mV or higher, it means the receiver is in regenerative mode. In that case, the receiver sensitivity will be worse than expected.
7. Supply bypass and shielding: All of the inductors, the quad tank, and their shield must be grounded. A 10-15 μ F or higher value tantalum capacitor on the supply line is essential. A low frequency ESR screening test on this capacitor will ensure consistent good sensitivity in production. A 0.1 μ F bypass capacitor on the supply pin, and grounded near the 44.545MHz oscillator improves sensitivity by 2-3dB.
8. R5 can be used to bias the oscillator transistor at a higher current for operation above 45MHz. Recommended value is 10k Ω .

Low-voltage high performance mixer FM IF system

SA606

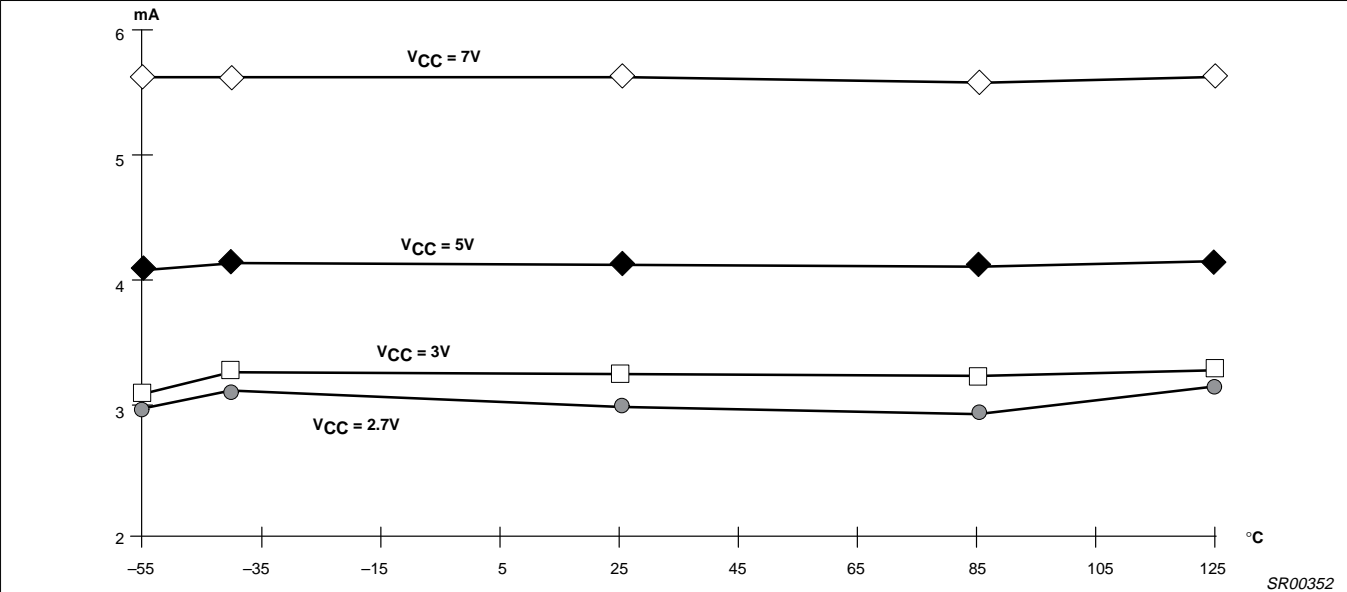

Figure 6. I_{CC} vs Temperature

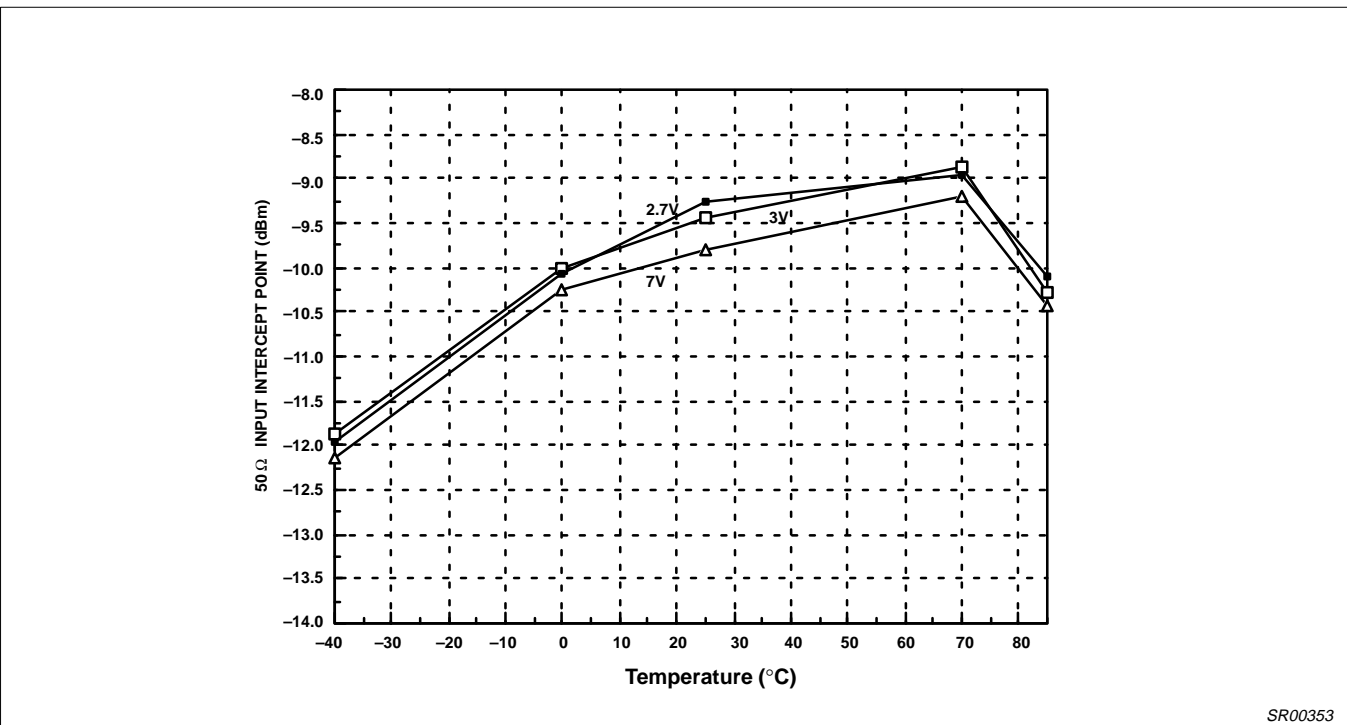
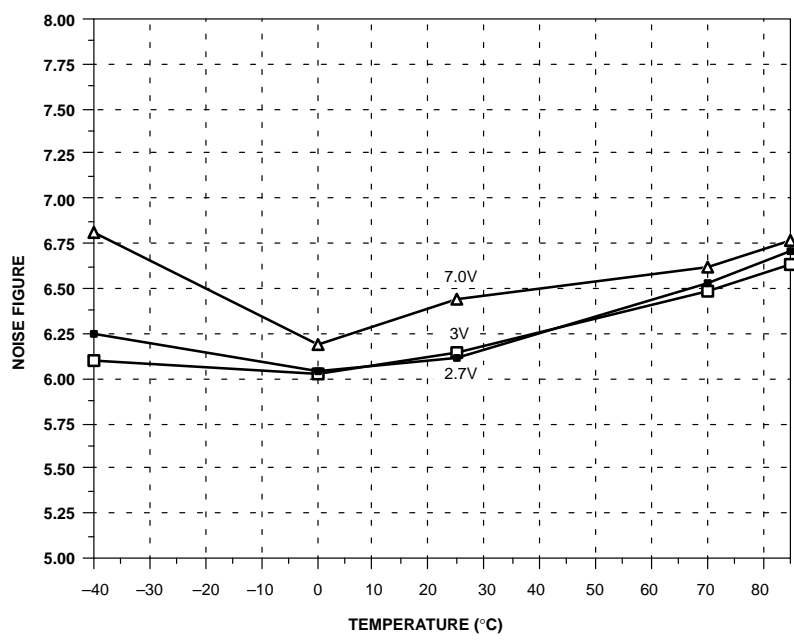

Figure 7. Third Order Intercept Point vs Supply Voltage

Low-voltage high performance mixer FM IF system

SA606



SR00354

Figure 8. Mixer Noise Figure vs Supply Voltage

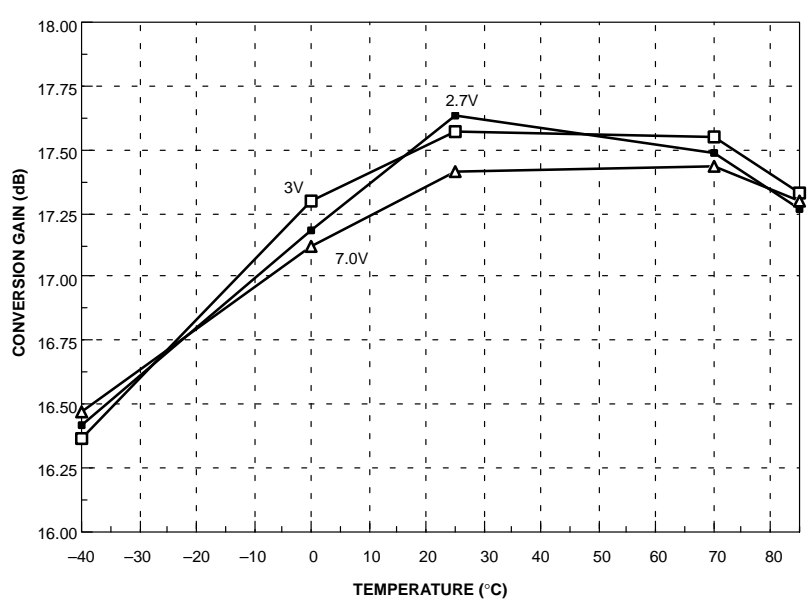

SR00355

Figure 9. Conversion Gain vs Supply Voltage

Low-voltage high performance mixer FM IF system

SA606

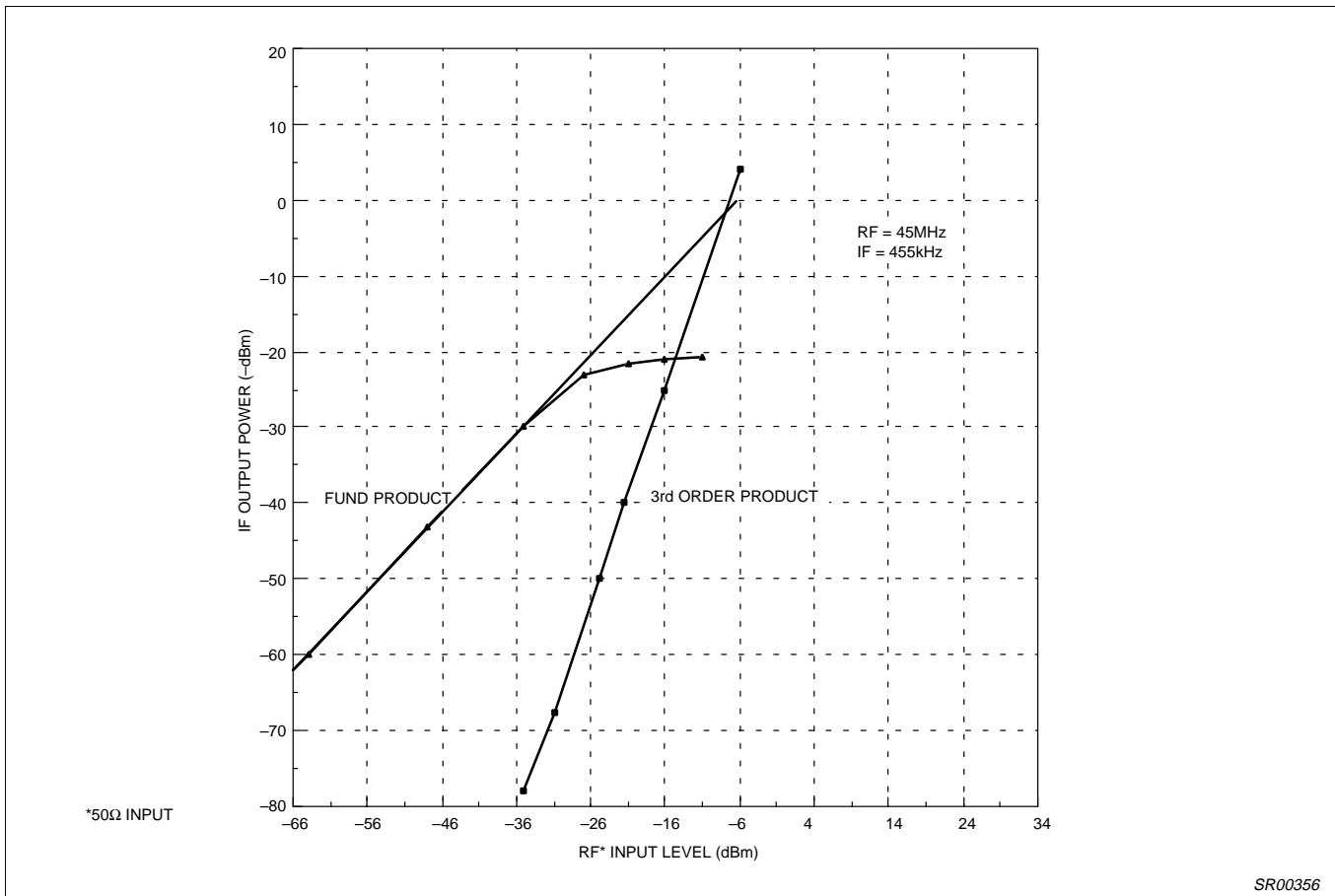

Figure 10. Mixer Third Order Intercept and Compression

SR00356

Low-voltage high performance mixer FM IF system

SA606

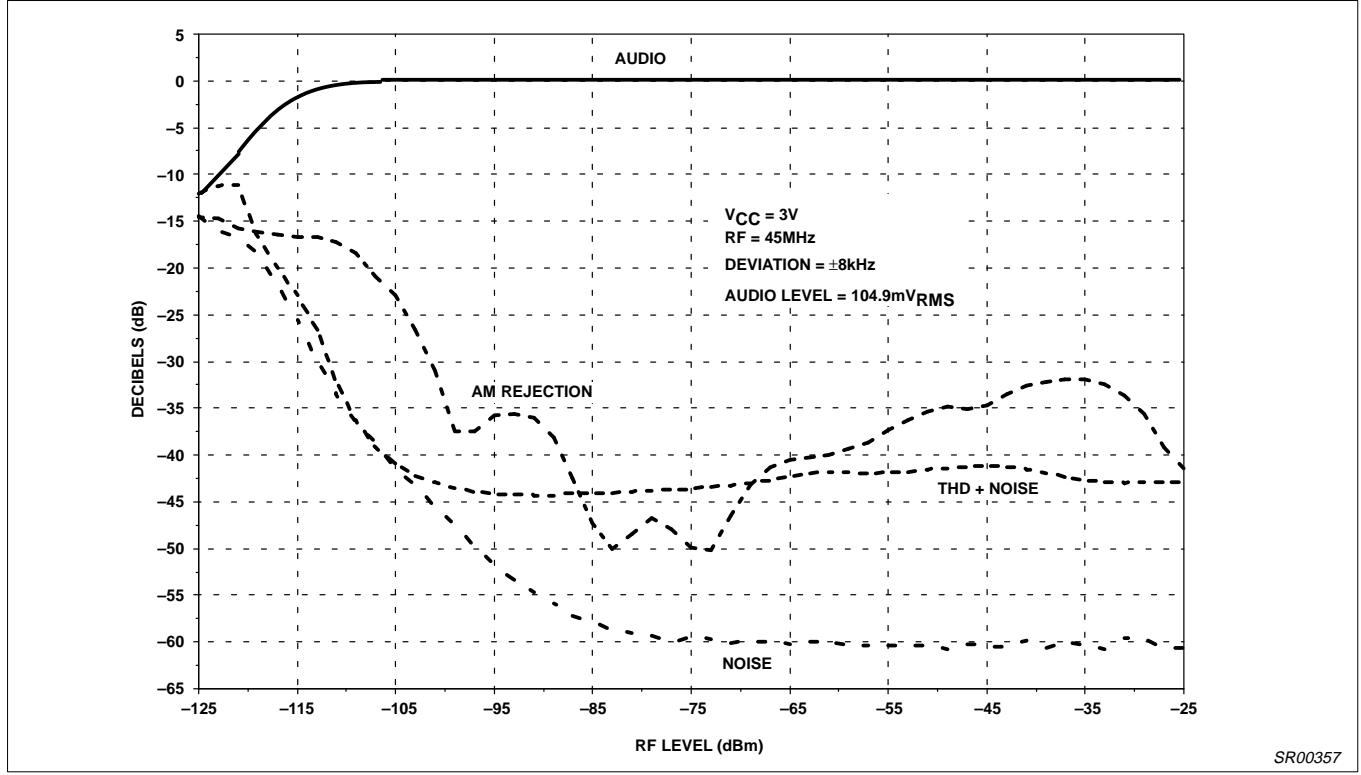

Figure 11. Sensitivity vs RF Level (-40°C)

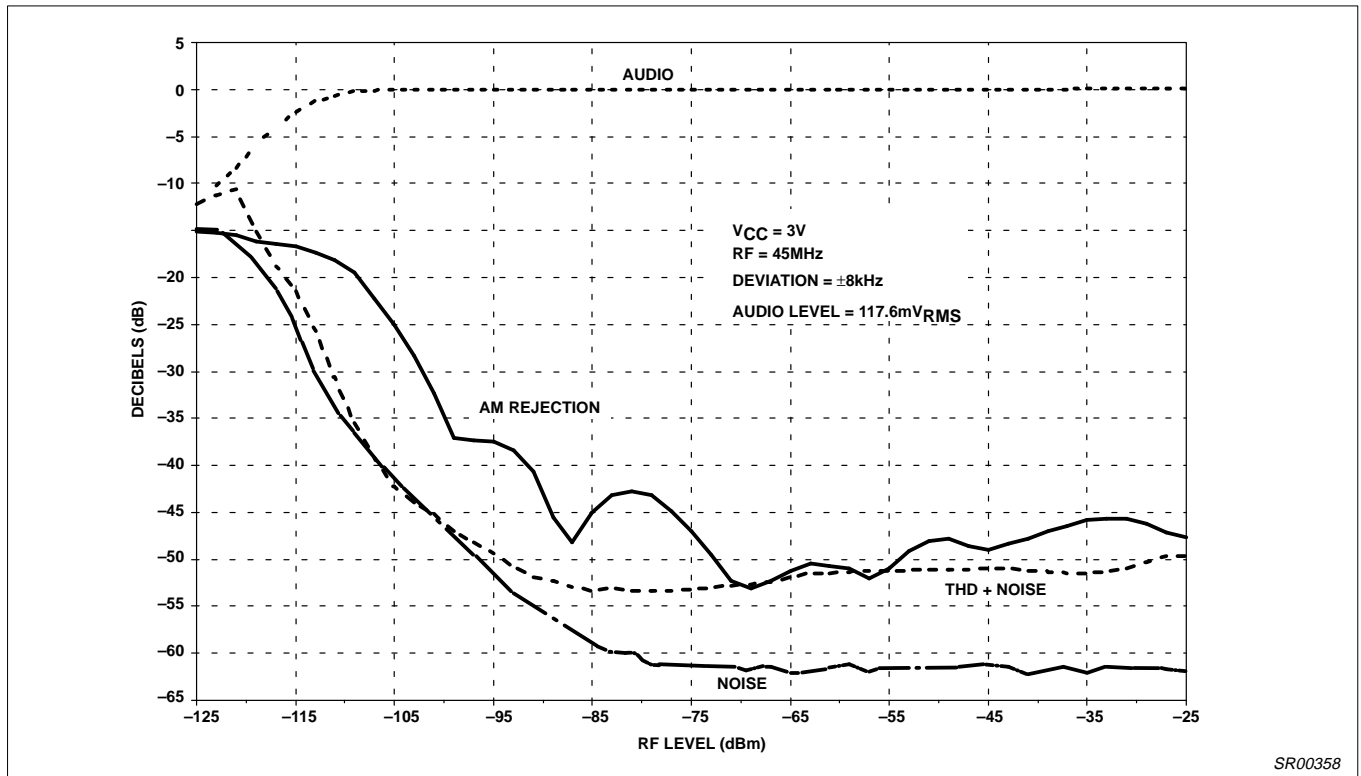

Figure 12. Sensitivity vs RF Level (+25°C)

Low-voltage high performance mixer FM IF system

SA606

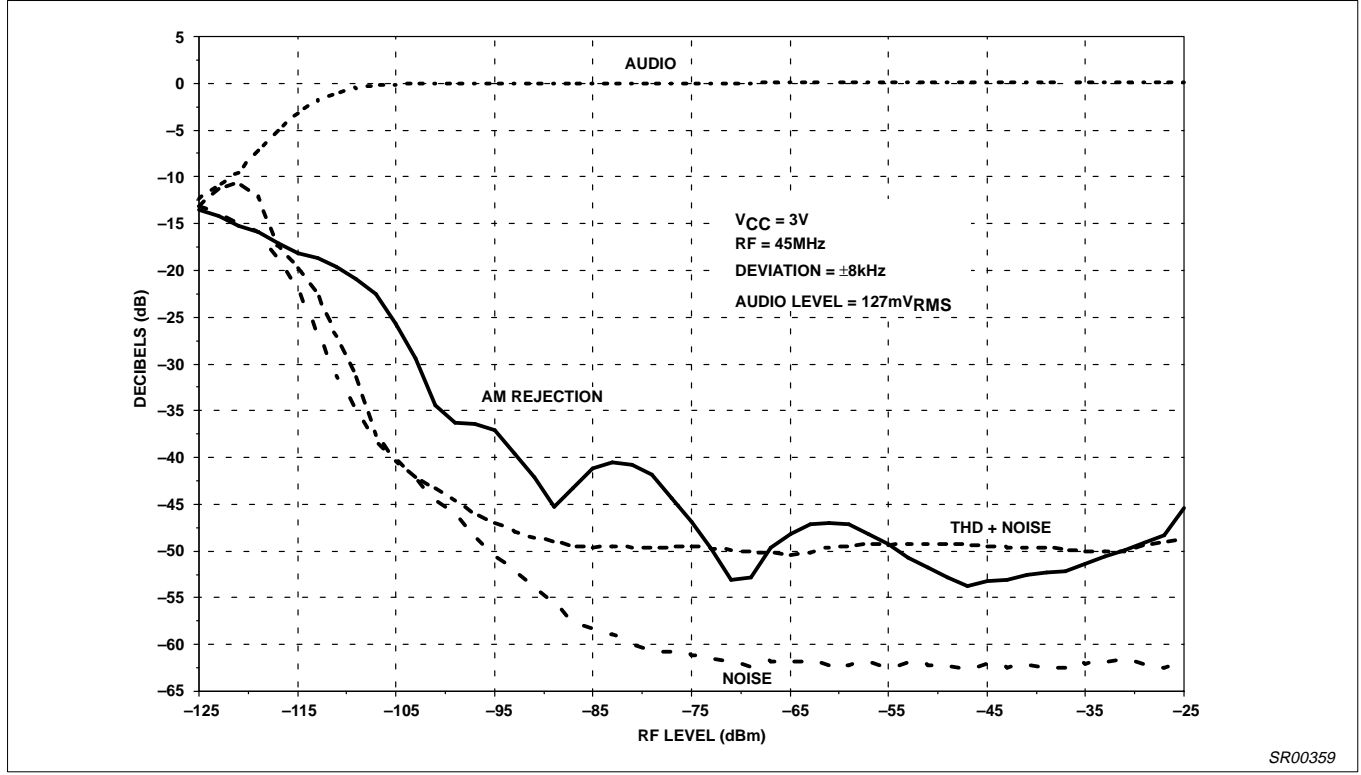

Figure 13. Sensitivity vs RF Level (Temperature 85°C)

SR00359

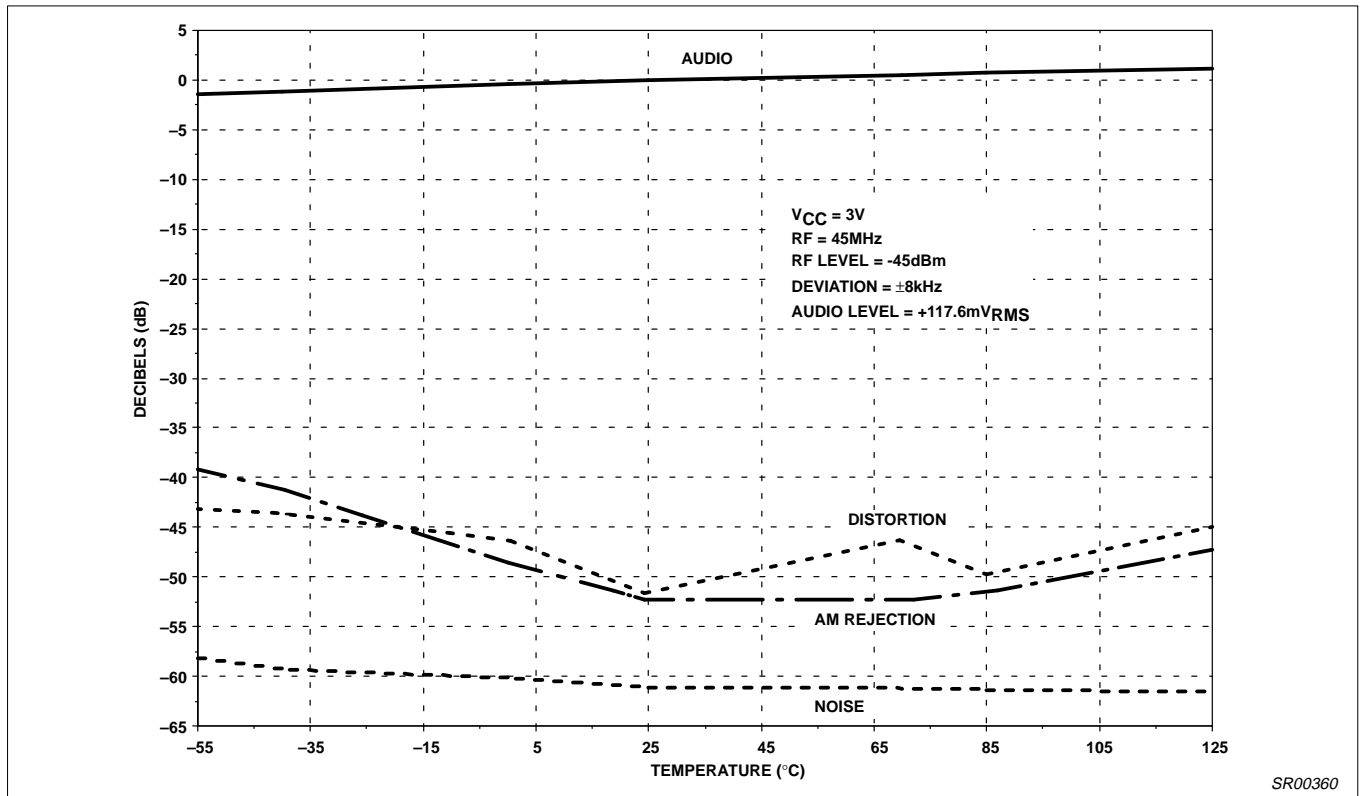

Figure 14. Relative Audio Level, Distortion, AM Rejection and Noise vs Temperature

SR00360

Low-voltage high performance mixer FM IF system

SA606

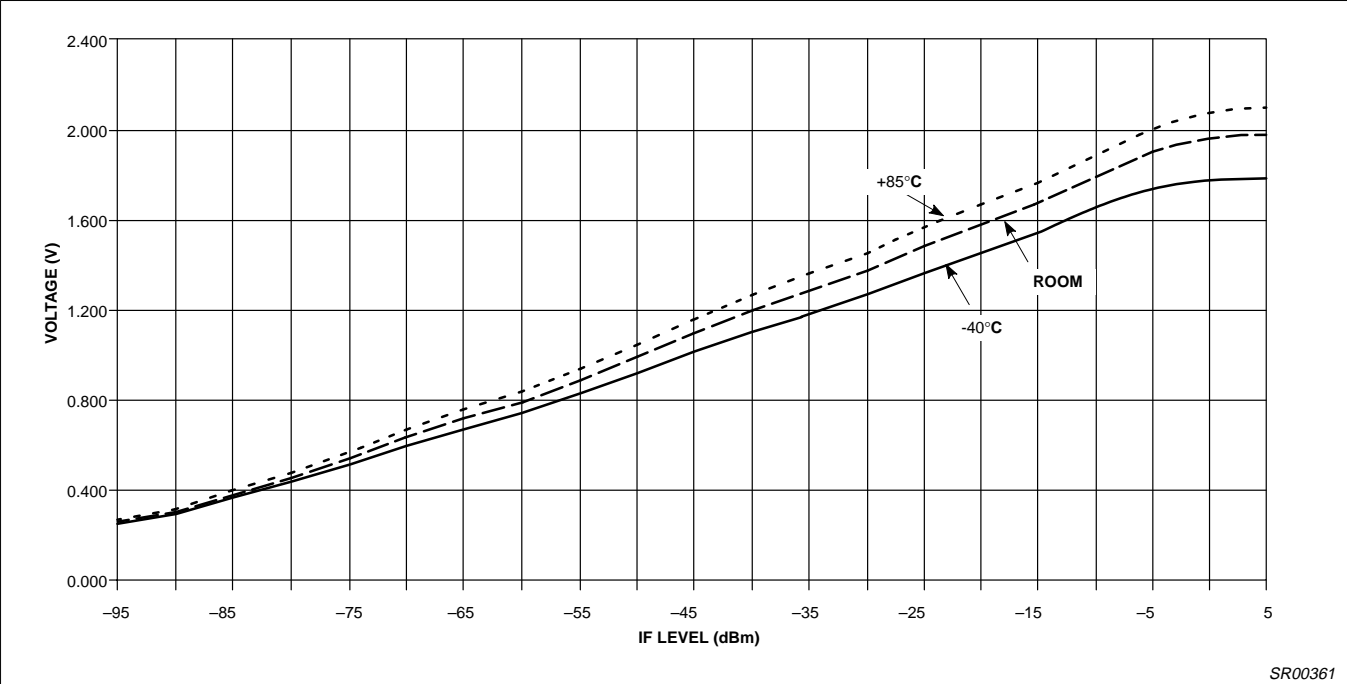

Figure 15. RSSI (455kHz IF @ 3V)

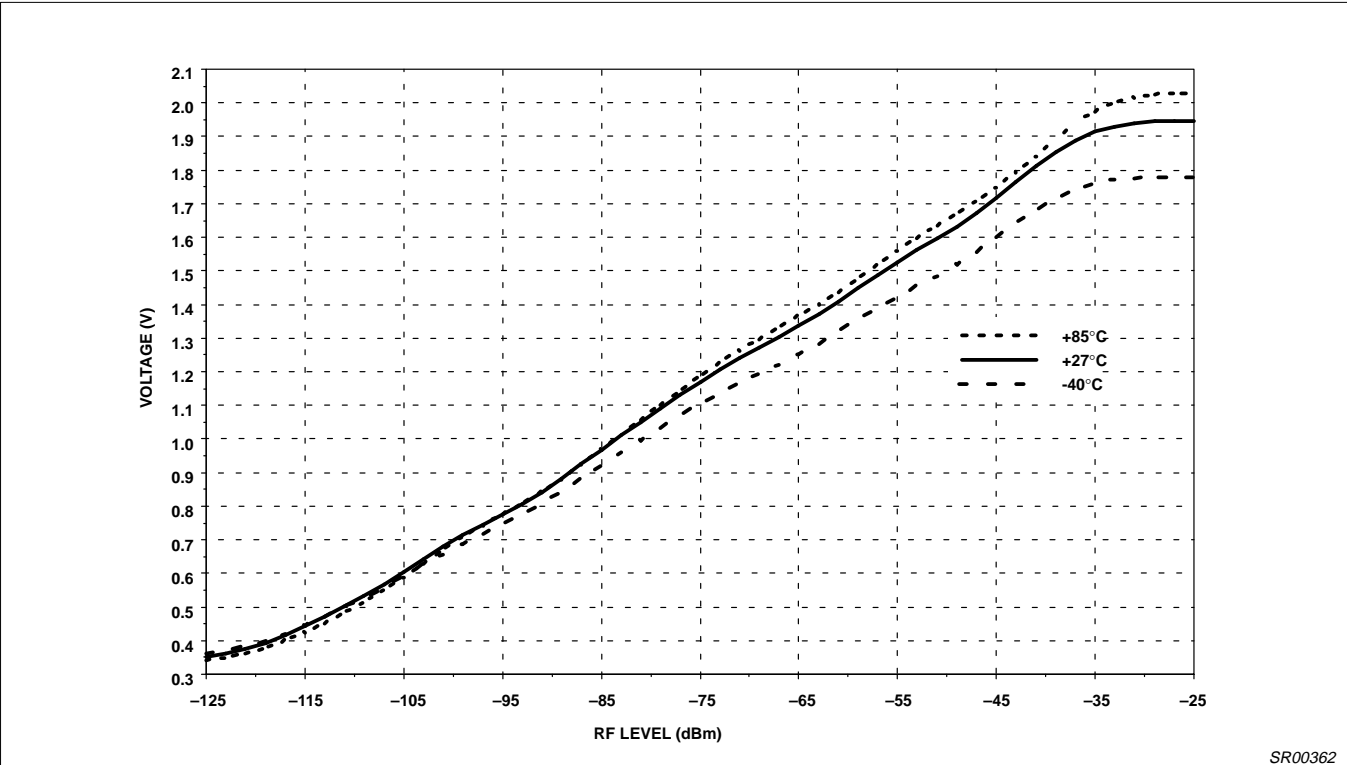
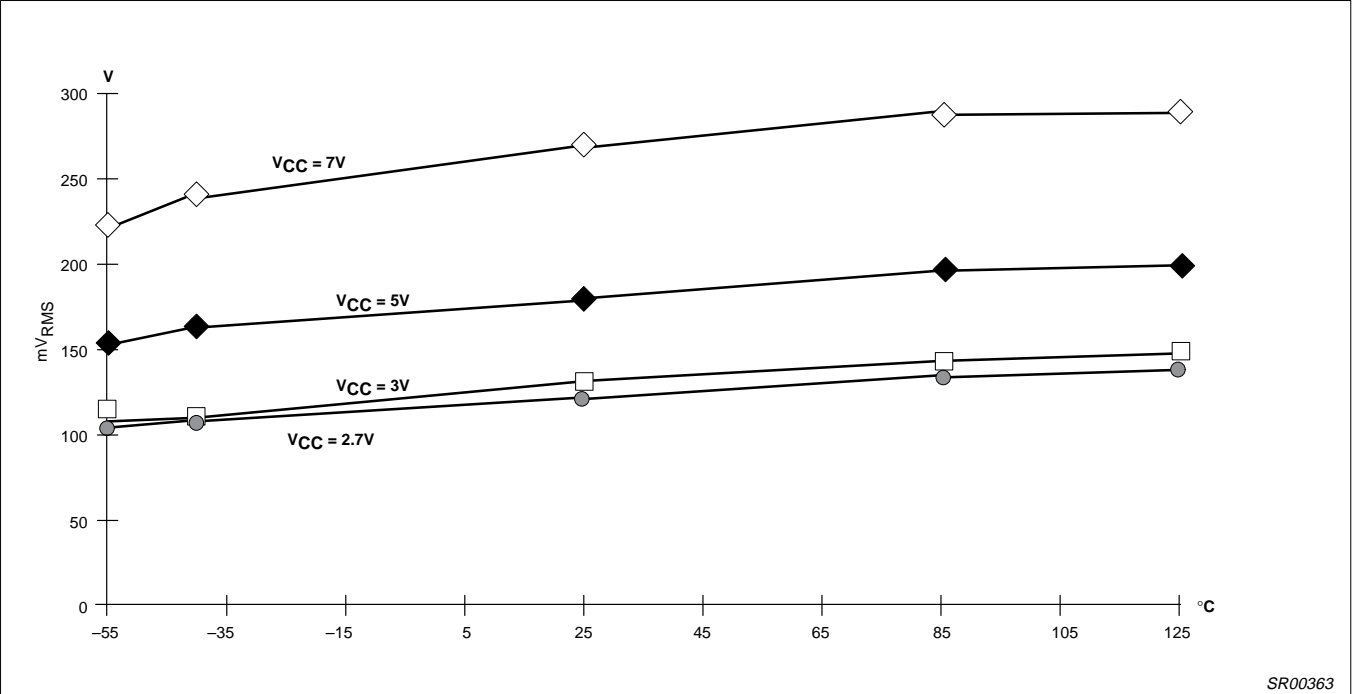

Figure 16. RSSI vs RF Level and Temperature - V_{CC} = 3V

Low-voltage high performance mixer FM IF system

SA606



SR00363

Figure 17. Audio Output vs Temperature

Low-voltage high performance mixer FM IF system

SA606

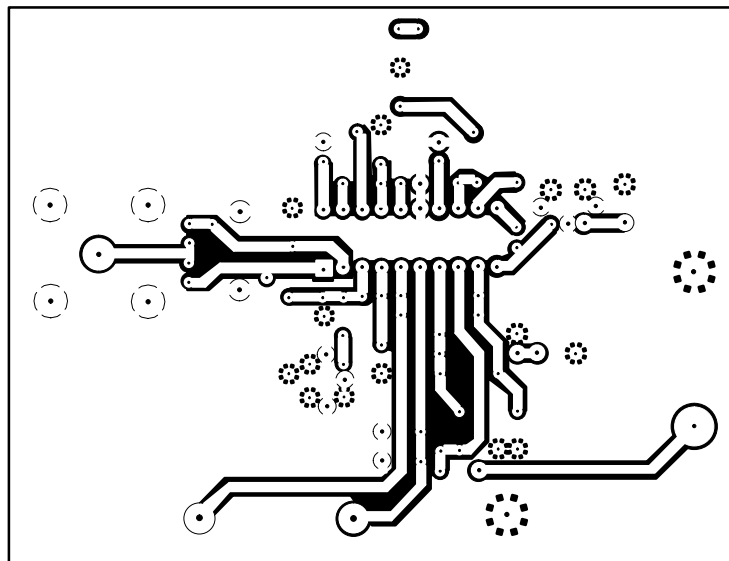
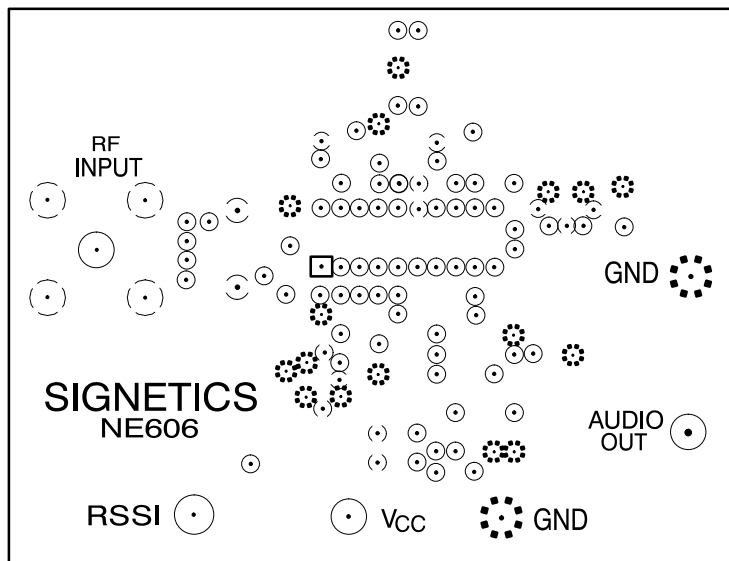

*Applies to Stand-Alone data sheets only.

SR00364

Figure 18. SA606N DIP Product Board Layout (Actual Size* — For Reference Use Only)

Low-voltage high performance mixer FM IF system

SA606

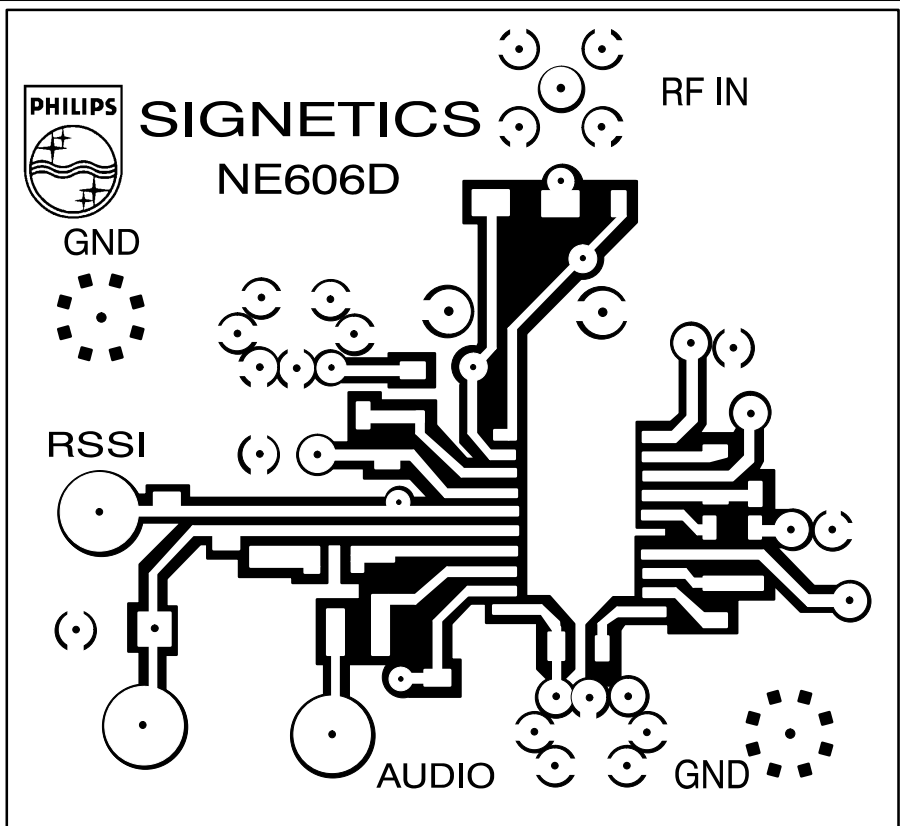

*Applies to Stand-Alone data sheets only.

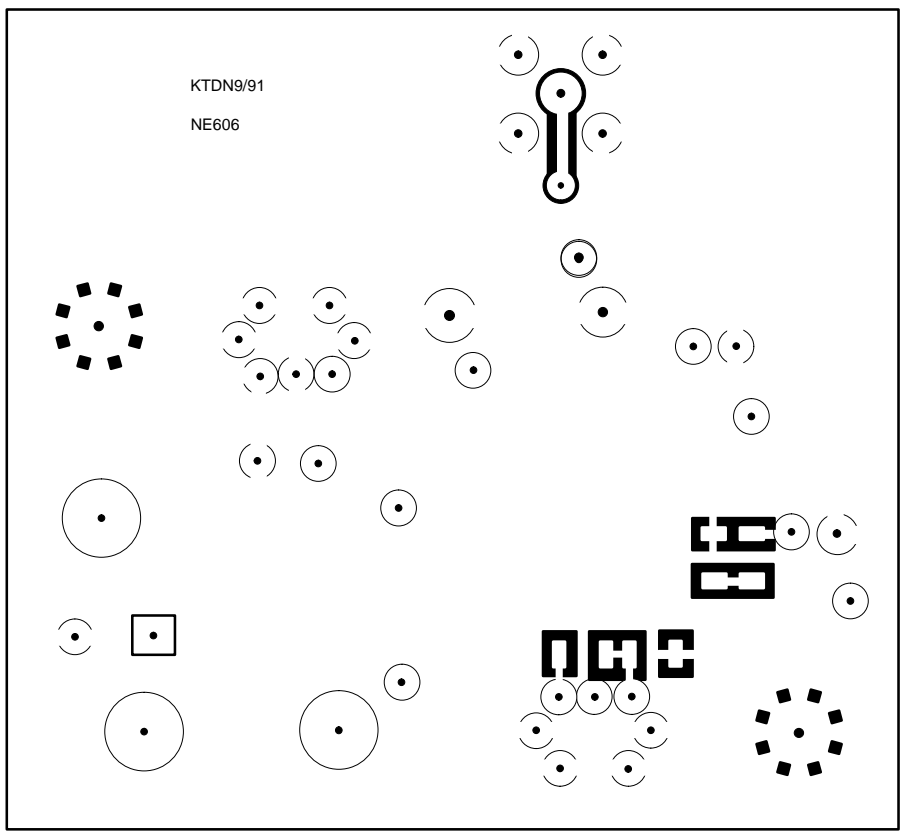

Figure 19. SA606D SOL Product Board Layout (2X Actual Size* — For Reference Use Only)

SR00365

Low-voltage high performance mixer FM IF system

SA606

606 Silk Screen

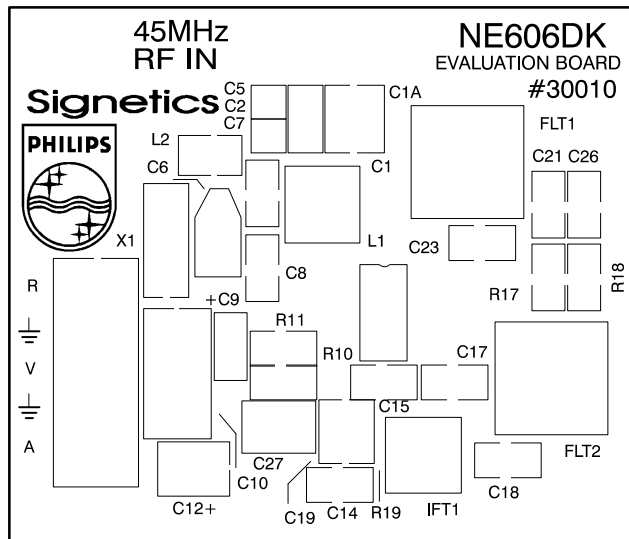

606 TOP

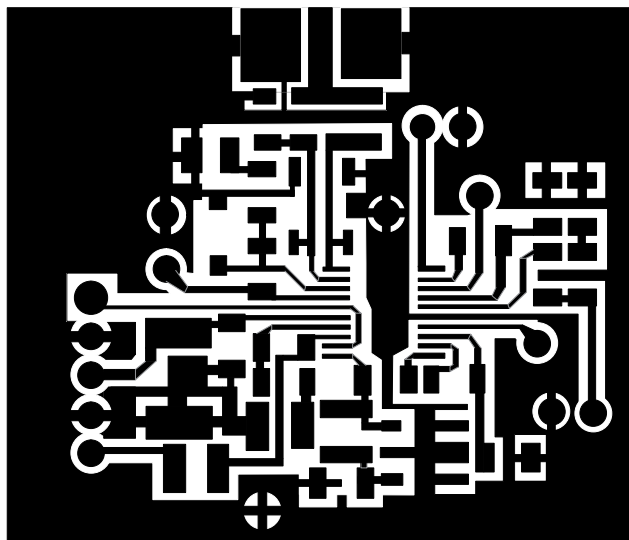

606 BOTTOM

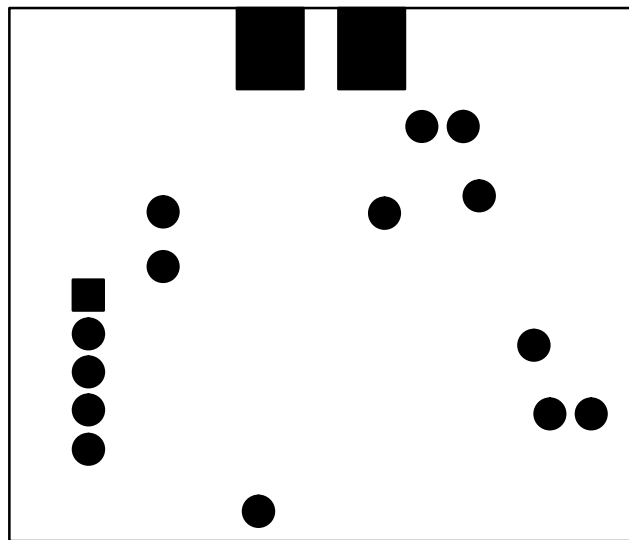

NOTE;
All views are TOP VIEW and
not actual size. For reference only.

SR00366

Figure 20.