

1GHz low voltage LNA, mixer and VCO

SA620

DESCRIPTION

The SA620 is a combined RF amplifier, VCO with tracking bandpass filter and mixer designed for high-performance low-power communication systems from 800-1200MHz. The low-noise preamplifier has a 1.6dB noise figure at 900MHz with 11.5dB gain and an IP3 intercept of -3dBm at the input. The gain is stabilized by on-chip compensation to vary less than $\pm 0.2\text{dB}$ over -40 to +85°C temperature range. The wide-dynamic-range mixer has an 9dB noise figure and IP3 of -6dBm at the input at 900MHz. An external LO can be used in place of the internal VCO for improved mixer input IP3 and a 3mA reduction in current. The chip incorporates a through-mode option so the RF amplifier can be disabled and replaced by an attenuator ($S_{21} = -7.5\text{dB}$). This is useful for improving the overall dynamic range of the receiver when in an overload situation. The nominal current drawn from a single 3V supply is 10.4mA and 7.2mA in the thru-mode. Additionally, the VCO and Mixer can be powered down to further reduce the supply current to 1.2mA.

FEATURES

- Low current consumption: 10.4mA nominal, 7.2mA with thru-mode activated
- Outstanding noise figure: 1.6dB for the amplifier and 9dB for the mixer at 900MHz
- Excellent gain stability versus temperature and supply voltage
- Switchable overload capability
- Independent LNA, mixer and VCO power down capability
- Internal VCO automatic leveling loop
- Monotonic VCO frequency vs control voltage

PIN CONFIGURATION

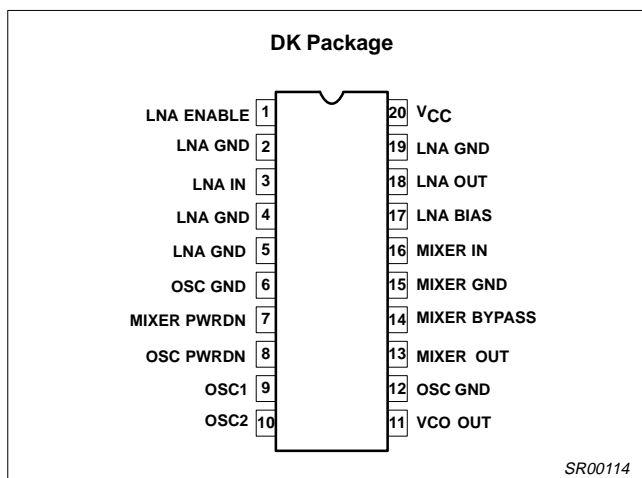

Figure 1. Pin Configuration

APPLICATIONS

- 900MHz cellular front-end
- 900MHz cordless front-end
- Spread spectrum receivers
- RF data links
- UHF frequency conversion
- Portable radio

ORDERING INFORMATION

DESCRIPTION	TEMPERATURE RANGE	ORDER CODE	DWG #
20-Pin Plastic Shrink Small Outline Package (Surface-mount, SSOP)	-40 to +85°C	SA620DK	SOT266-1

BLOCK DIAGRAM

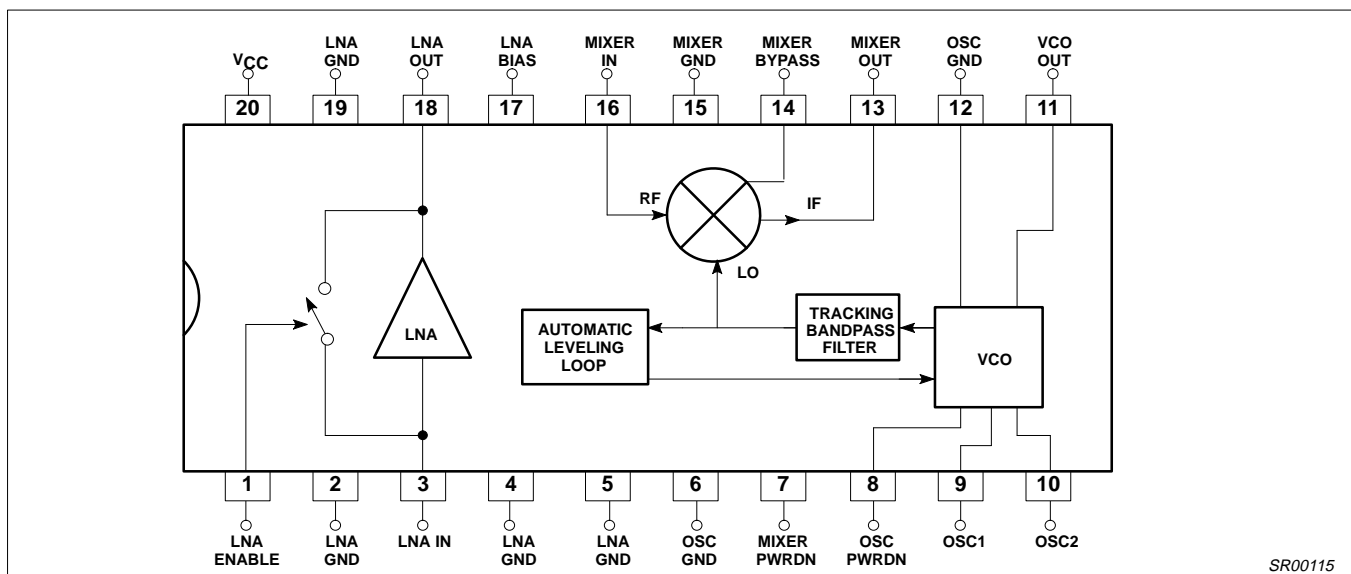

Figure 2. Block Diagram

1GHz low voltage LNA, mixer and VCO

SA620

ABSOLUTE MAXIMUM RATINGS

SYMBOL	PARAMETER	RATING	UNITS
V_{CC}	Supply voltage ¹	-0.3 to +6	V
V_{IN}	Voltage applied to any other pin	-0.3 to ($V_{CC} + 0.3$)	V
P_D	Power dissipation, $T_A = 25^\circ\text{C}$ (still air) ² 20-Pin Plastic SSOP	980	mW
T_{JMAX}	Maximum operating junction temperature	150	$^\circ\text{C}$
P_{MAX}	Maximum power input/output	+20	dBm
T_{STG}	Storage temperature range	-65 to +150	$^\circ\text{C}$

NOTE:

- Transients exceeding 8V on V_{CC} pin may damage product.
- Maximum dissipation is determined by the operating ambient temperature and the thermal resistance, θ_{JA} : 20-Pin SSOP = 110 $^\circ\text{C}/\text{W}$

RECOMMENDED OPERATING CONDITIONS

SYMBOL	PARAMETER	RATING	UNITS
V_{CC}	Supply voltage	2.7 to 5.5	V
T_A	Operating ambient temperature range	-40 to +85	$^\circ\text{C}$
T_J	Operating junction temperature	-40 to +105	$^\circ\text{C}$

DC ELECTRICAL CHARACTERISTICS

 $V_{CC} = +3\text{V}$, $T_A = 25^\circ\text{C}$; unless otherwise stated.

SYMBOL	PARAMETER	TEST CONDITIONS	LIMITS			UNITS
			MIN	TYP	MAX	
I_{CC}	Supply current	LNA enable input high		10.4		mA
		LNA enable input low		7.2		mA
		VCO power-down input low		7.4		mA
		Mixer power-down input low		7.4		mA
		Full chip power-down		1.2		mA
V_T	Enable logic threshold voltage ^{NO TAG}		1.2	1.5	1.8	V
V_{IH}	Logic 1 level	RF amp on	2.0		V_{CC}	V
V_{IL}	Logic 0 level	RF amp off	-0.3		0.8	V
I_{IL}	Enable input current	Enable = 0.4V	-1	0	1	μA
I_{IH}	Enable input current	Enable = 2.4V	-1	0	1	μA
V_{LNA-IN}	LNA input bias voltage	Enable = 2.4V		0.78		V
$V_{LNA-OUT}$	LNA output bias voltage	Enable = 2.4V		2.1		V
V_B	LNA bias voltage	Enable = 2.4V		2.1		V
V_{MX-IN}	Mixer RF input bias voltage			0.94		V

NOTE:

- The ENABLE input must be connected to a valid logic level for proper operation of the SA620 LNA.

1GHz low voltage LNA, mixer and VCO

SA620

AC ELECTRICAL CHARACTERISTICS

 $V_{CC} = +3V$, $T_A = 25^{\circ}C$; Enable = +3V; unless otherwise stated.

SYMBOL	PARAMETER	TEST CONDITIONS	LIMITS			UNITS
			-3 σ	TYP	+3 σ	
S_{21}	Amplifier gain	900MHz	10	11.5	13	dB
S_{21}	Amplifier gain in through mode	Enable = 0.4V, 900MHz	-9	-7.5	-6	dB
$\Delta S_{21}/\Delta T$	Gain temperature sensitivity in pwr-dwn mode	900MHz		-0.014		dB/ $^{\circ}C$
$\Delta S_{21}/\Delta T$	Gain temperature sensitivity enabled	900MHz		0.003		dB/ $^{\circ}C$
$\Delta S_{21}/\Delta f$	Gain frequency variation	800MHz - 1.2GHz		0.01		dB/MHz
S_{12}	Amplifier reverse isolation	900MHz		-20		dB
S_{11}	Amplifier input match ¹	900MHz		-10		dB
S_{22}	Amplifier output match ¹	900MHz		-12		dB
P_{-1dB}	Amplifier input 1dB gain compression	900MHz		-16		dBm
IP3	Amplifier input third order intercept	900MHz	-4.5	-3	-1.5	dBm
NF	Amplifier noise figure	900MHz	1.3	1.6	1.9	dB
t_{ON}	Amplifier turn-on time (Enable Lo \rightarrow Hi)	See Figure 3		50		μs
t_{OFF}	Amplifier turn-off time (Enable Hi \rightarrow Lo)	See Figure 3		5		μs
V_{GC}	Mixer voltage conversion gain: $R_P = R_L = 1k\Omega$,	$f_S = 0.9GHz$, $f_{LO} = 0.8GHz$, $f_{IF} = 100MHz$	14.5	16	17.5	dB
P_{GC}	Mixer power conversion gain: $R_P = R_L = 1k\Omega$,	$f_S = 0.9GHz$, $f_{LO} = 0.8GHz$, $f_{IF} = 100MHz$	1.5	3	4.5	dB
S_{11M}	Mixer input match ¹	900MHz		-10		dB
NF_M	Mixer SSB noise figure	900MHz	7.5	9	10.5	dB
P_{-1dB}	Mixer input 1dB gain compression	900MHz		-13		dBm
IP3 _M	Mixer input third order intercept	$f_2 - f_1 = 1MHz$, 900MHz	-7.5	-6	-4.5	dBm
IP2 _{INT}	Mixer input second order intercept	900MHz		12		dBm
P_{RFM-IF}	Mixer RF feedthrough	900MHz		-20		dB
P_{LO-IF}	LO feedthrough to IF	900MHz		-25		dBm
P_{LO-RFM}	LO to mixer input feedthrough	900MHz		-30		dBm
P_{LO-RF}	LO to LNA input feedthrough	900MHz		-45		dBm
P_{VCO}	VCO buffer out	900MHz		-16		dBm
	VCO frequency range		300 (min)		1200 (max)	MHz
	VCO phase noise	Offset = 60kHz		-105		dBc/Hz

NOTE:

1. Simple L/C elements are needed to achieve specified return loss.

1GHz low voltage LNA, mixer and VCO

SA620

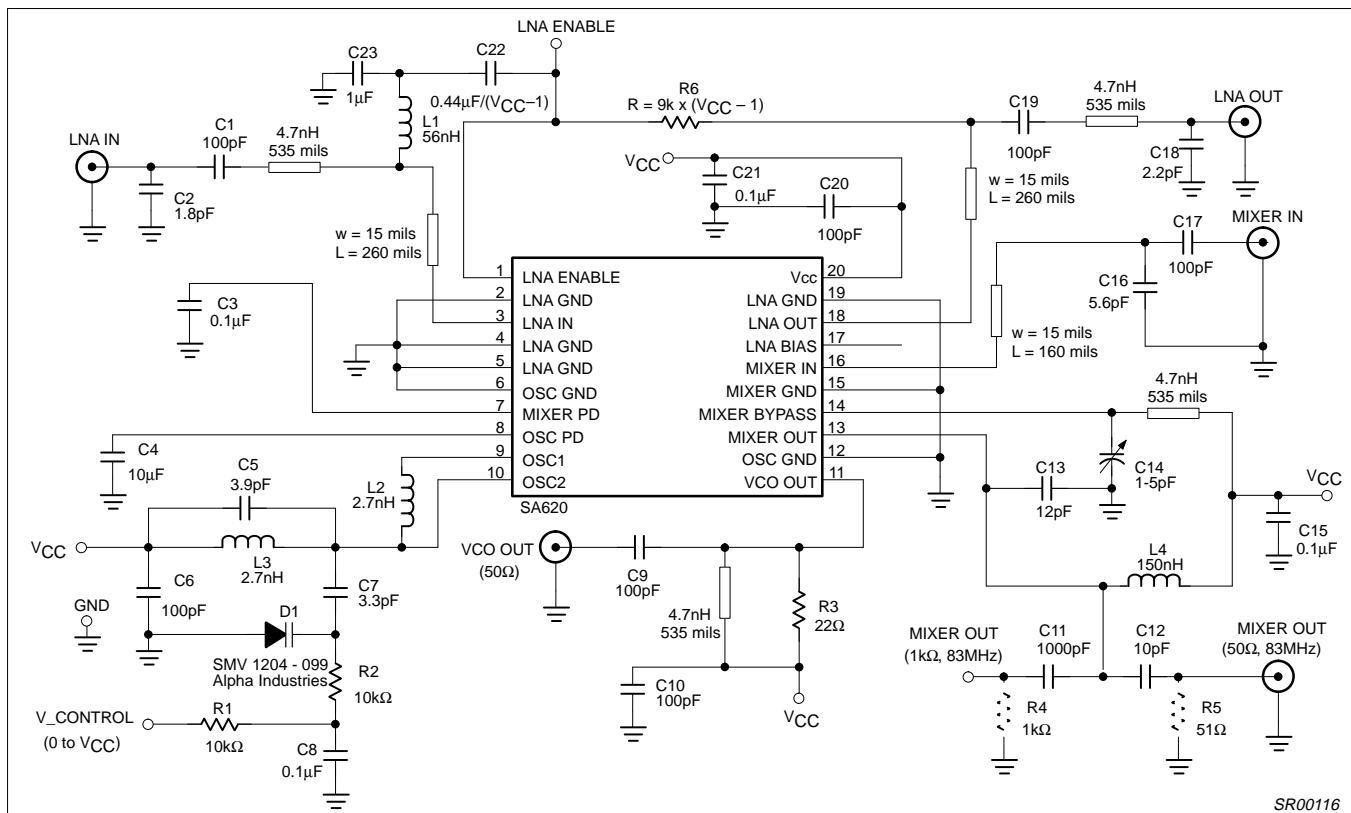

Figure 3. A Complete LNA, Mixer and VCO

CIRCUIT TECHNOLOGY

LNA

Impedance Match: Intrinsic return loss at the input and output ports is 7dB and 9dB, respectively. With no external matching, the associated LNA gain is ≈ 10 dB and the noise figure is ≈ 1.4 dB. However, the return loss can be improved at 900MHz using suggested L/C elements (Figure NO TAG) as the LNA is unconditionally stable.

Noise Match: The LNA achieves 1.6dB noise figure at 900MHz when $S_{11} = -10$ dB. Further improvements in S_{11} will slightly increase the NF and S_{21} .

Thru-Mode: A series switch can be activated to feed RF signals from LNA input to output with an attenuator ($S_{21} = -7.5$ dB). As a result, the power handling is greatly improved and current consumption is decreased by 3.2mA as well. However, if this mode is not required, C23 and R6 can be deleted.

Temperature Compensation: The LNA has a built-in temperature compensation scheme to reduce the gain drift to 0.003dB/ $^{\circ}$ C from -40° C to $+85^{\circ}$ C.

Supply Voltage Compensation: Unique circuitry provides gain stabilization over wide supply voltage range. The gain changes no more than 0.5dB when V_{CC} increases from 3V to 5V.

Mixer

Input Match: The mixer is configured for maximum gain and best noise figure. The user needs to supply L/C elements to achieve this performance.

Mixer Bypass: To optimize the IP3 of the mixer input, one must adjust the value of C14 for the given board layout. The value

typically lies between 1 and 5pF. Once a value is selected, a fixed capacitor can be used. Further improvements in mixer IP3 can be achieved by inserting a resistive loss at the mixer input, at the expense of system gain and noise figure.

Tracking Bandpass Filter: At the LO input port of the mixer there is a second-order bandpass filter (approx. 50MHz bandwidth) which will track the VCO center frequency. The result is the elimination of low frequency noise injected into the mixer LO port without the need for an external LO filter.

Power Down: The mixer can be disabled by connecting Pin 7 to ground. If a Schottky diode is connected between Pin 1 (cathode) and Pin 7 (anode), the LNA disable signal will control both LNA and mixer simultaneously. When the mixer is disabled, 3mA is saved.

Test Port: Resistor R5 can be substituted with an external test port of 50 Ω input impedance. Since R5 and MIXER OUT have the same output power, the result is a direct power gain measurement.

VCO

Automatic Leveling Loop: An on-chip detector and loop amplifier will adjust VCO bias current to regulate the VCO amplitude regardless of the Q-factor (>10) of the resonator and varactor diode. However, the real current reduction will not occur until the VCO frequency falls below 500MHz. For a typical resonator the steady-state current is 3mA at 800MHz.

Buffered VCO Output: The VCO OUT (Pin 11) signal can drive an external prescaler directly (see also the Philips SA7025 low voltage, fractional-N synthesizer). The extracted signal levels need to be limited to -16 dBm or less to maintain mixer IIP3.

1GHz low voltage LNA, mixer and VCO

SA620

Phase Noise: If close-in phase noise is not critical, or if an external synthesizer is used, C4 (Pin 8) can be decreased to a lower value.

and Pin 8 (anode), the LNA disable signal will control both LNA and VCO simultaneously. When the VCO is disabled, 3mA is saved.

Power-Down: The VCO can be disabled by connecting Pin 8 to ground. If a Schottky diode is connected between Pin 1 (cathode)

TYPICAL PERFORMANCE CHARACTERISTICS

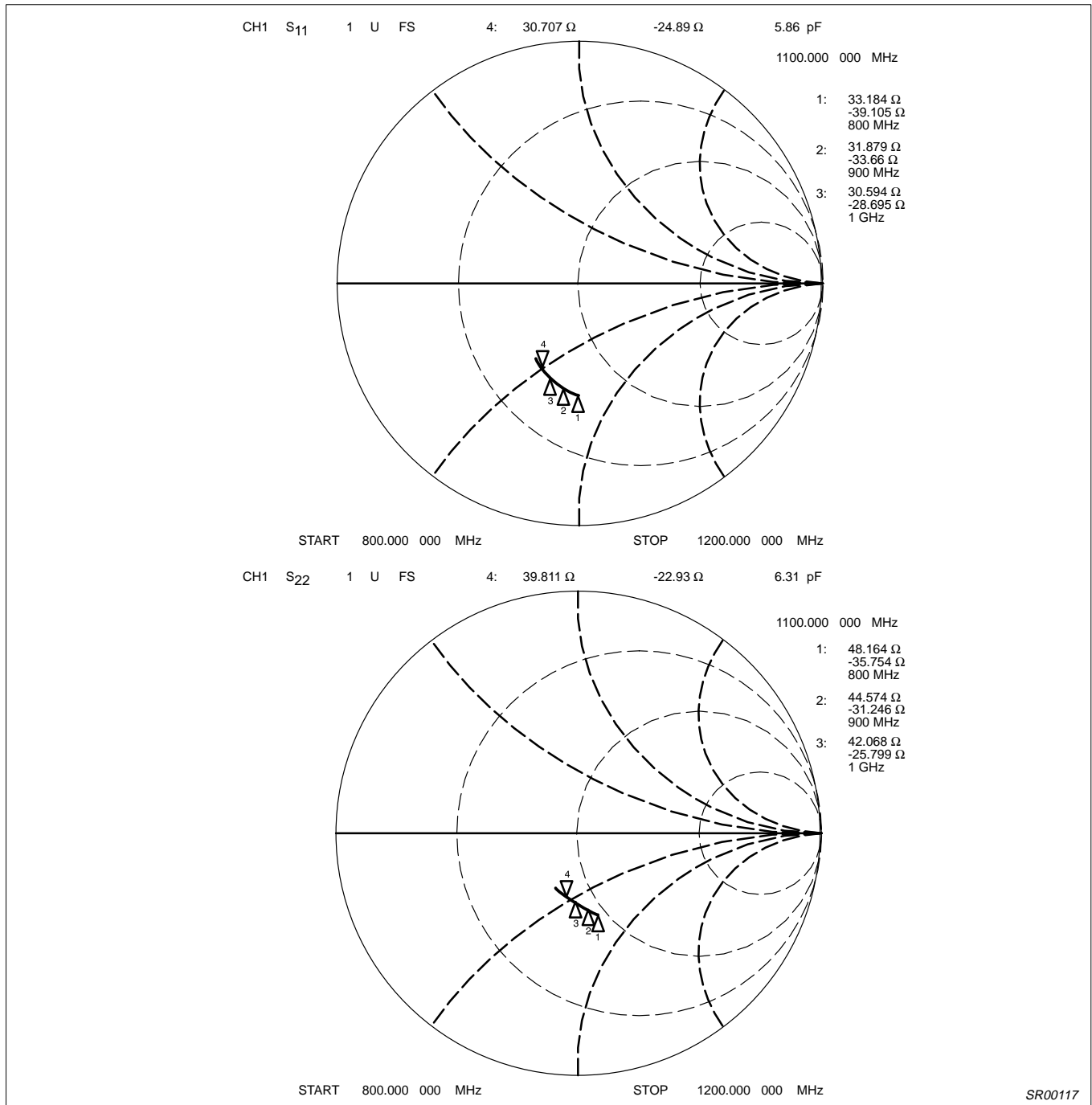

Figure 4. LNA Input and Output Match (at Device Pin)

SR00117

1GHz low voltage LNA, mixer and VCO

SA620

TYPICAL PERFORMANCE CHARACTERISTICS (Continued)

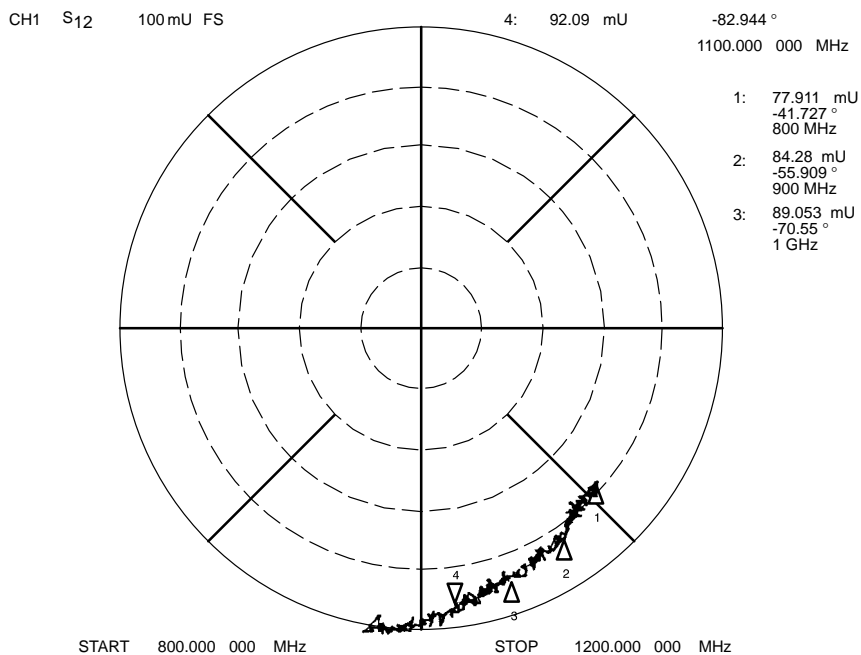
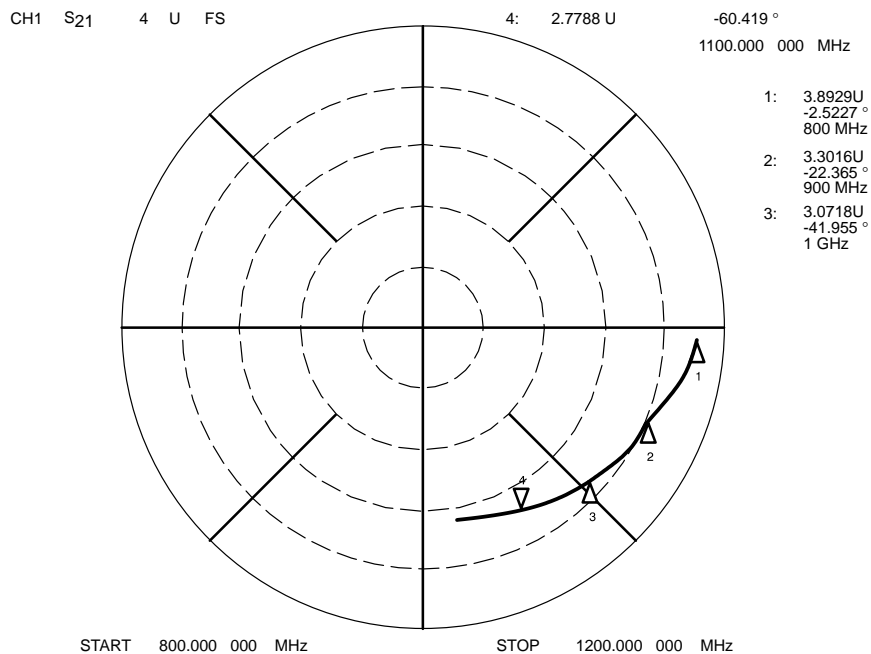

SR00118

Figure 5. LNA Transmission and Isolation Characteristics (at Device Pin)

1GHz low voltage LNA, mixer and VCO

SA620

TYPICAL PERFORMANCE CHARACTERISTICS (Continued)

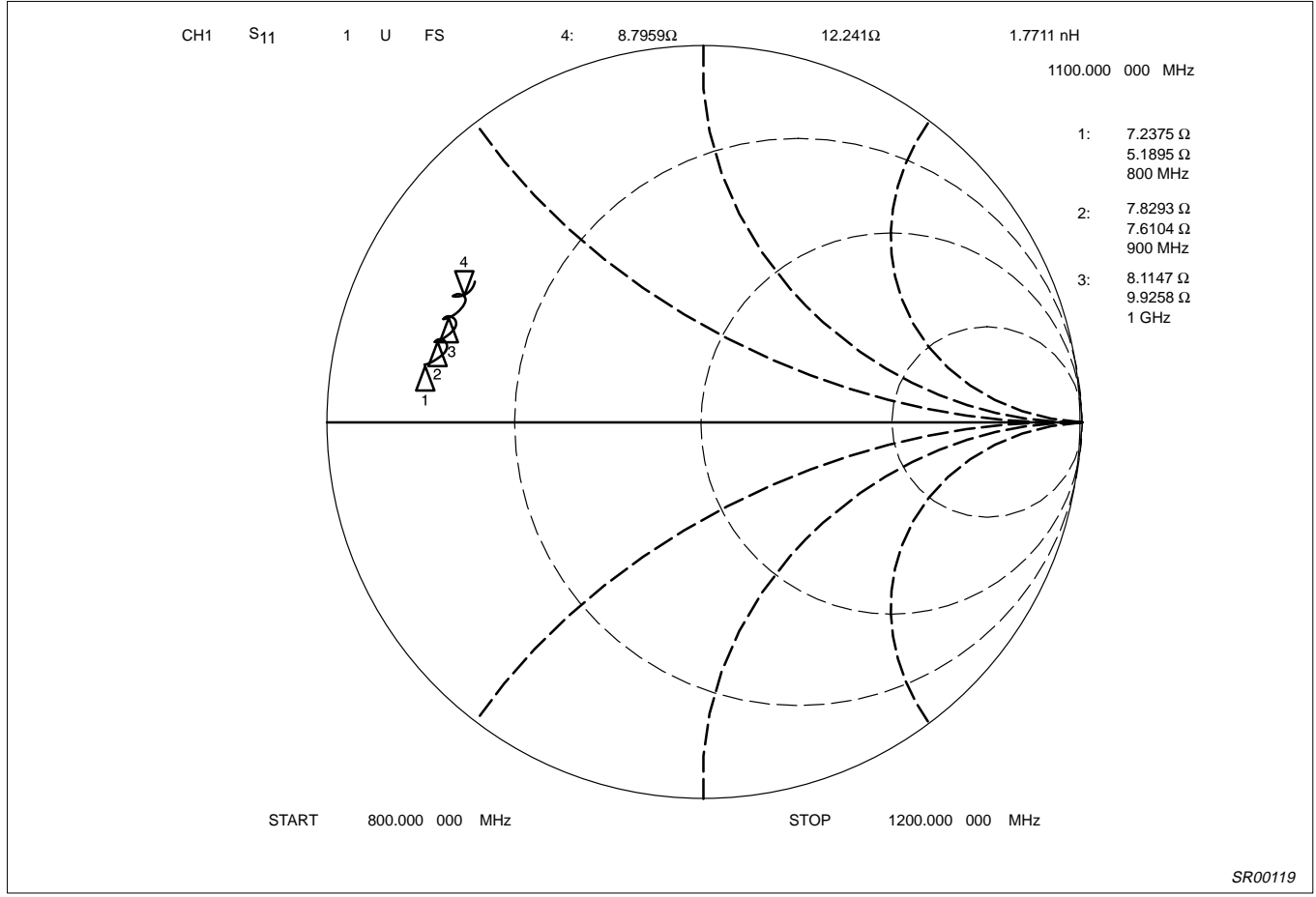

Figure 6. Mixer RF Input Match (at Device Pin)

1GHz low voltage LNA, mixer and VCO

SA620

TYPICAL PERFORMANCE CHARACTERISTICS (Continued)

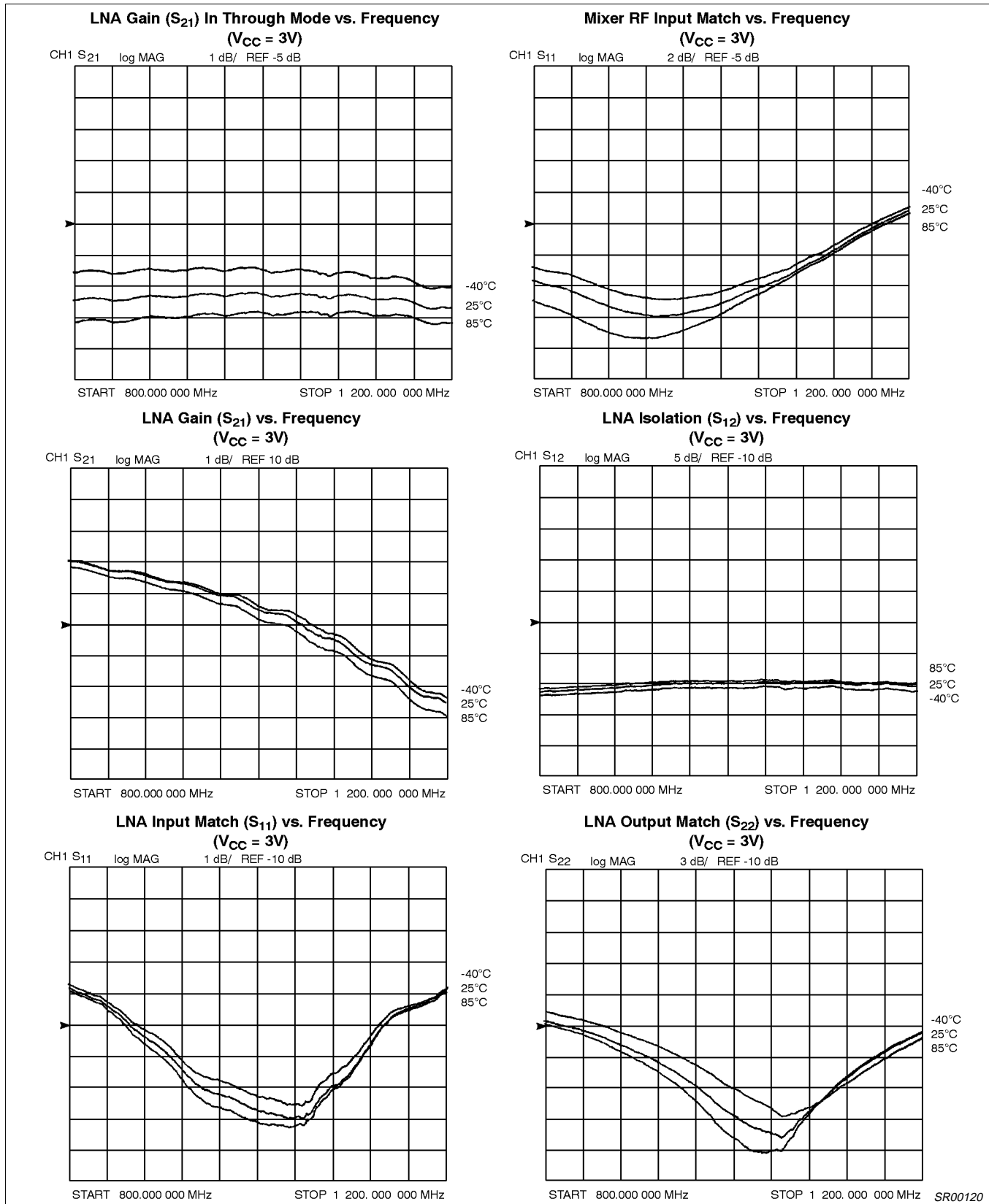

Figure 7. Typical Performance Characteristics (cont.)

SR00120

1GHz low voltage LNA, mixer and VCO

SA620

TYPICAL PERFORMANCE CHARACTERISTICS (Continued)

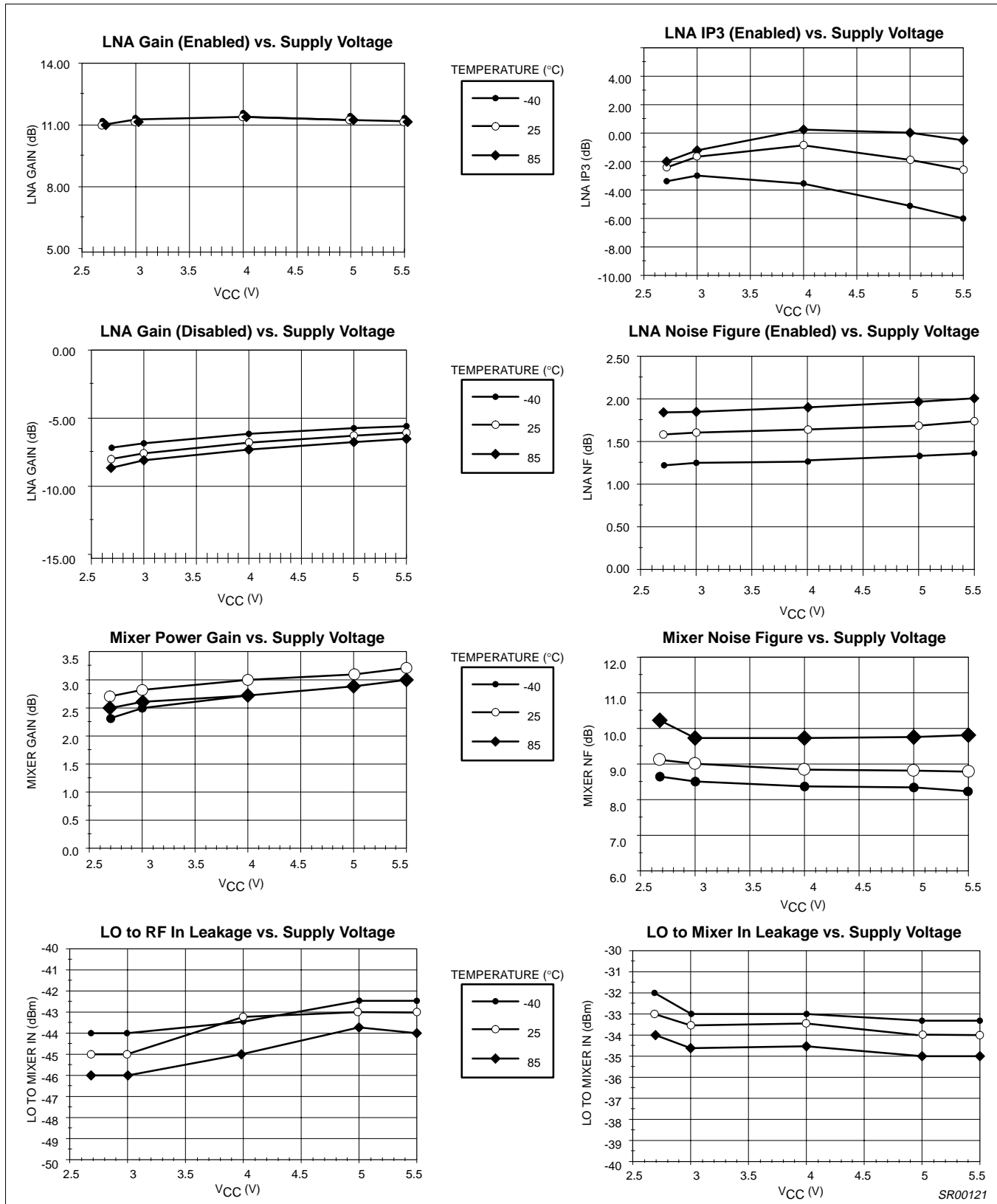

Figure 8. Typical Performance Characteristics (cont.)

SR00121

1GHz low voltage LNA, mixer and VCO

SA620

TYPICAL PERFORMANCE CHARACTERISTICS (Continued)

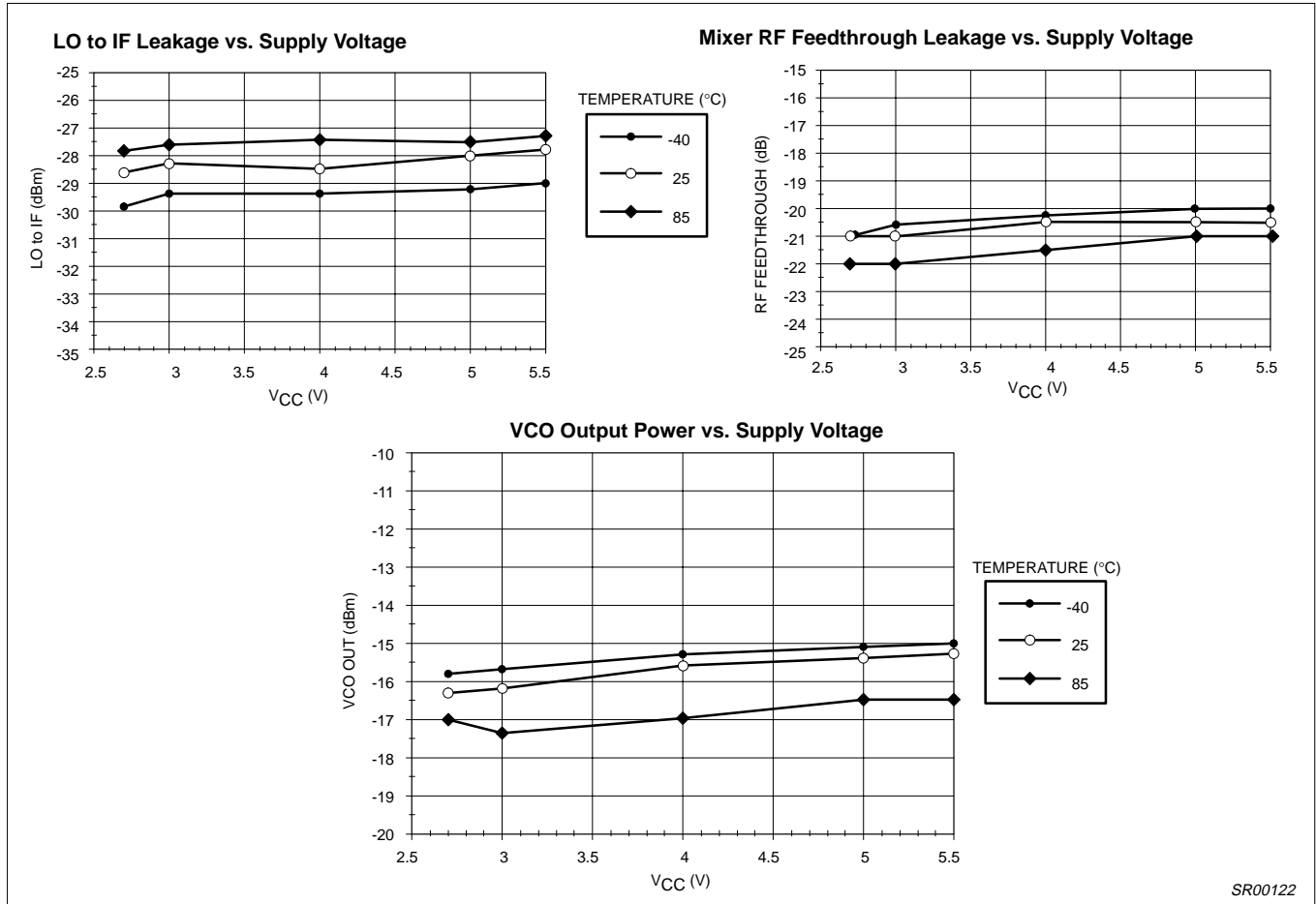

SR00122

Figure 9. Typical Performance Characteristics (cont.)

1GHz low voltage LNA, mixer and VCO

SA620

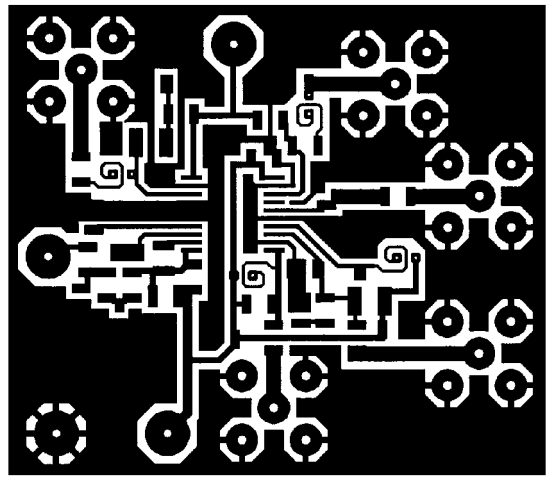
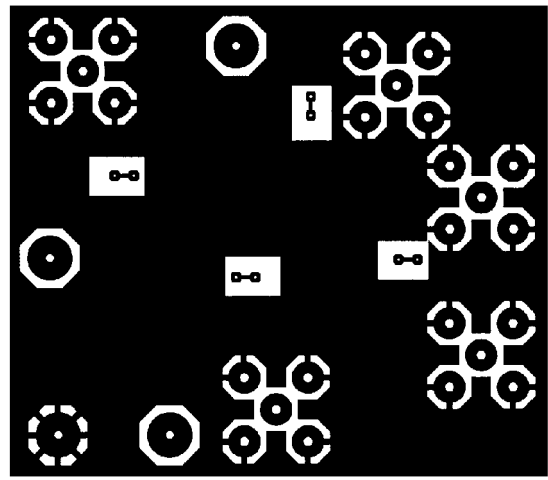
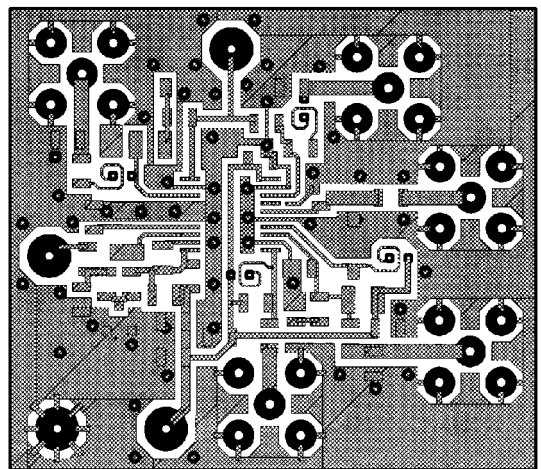
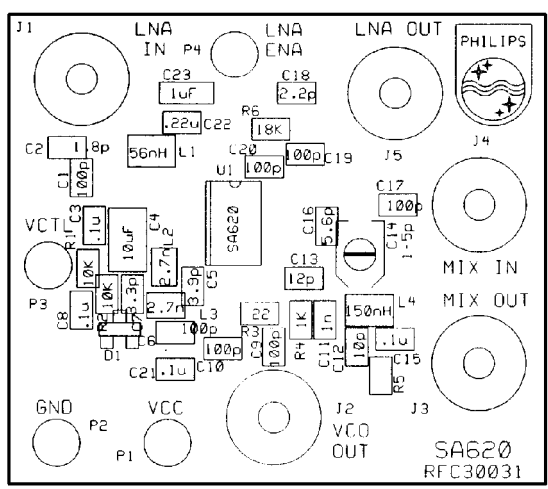

SR00123

Figure 10. Board Layout (NOT ACTUAL SIZE)