

Low voltage high performance mixer FM IF system with high-speed RSSI

SA636

DESCRIPTION

The SA636 is a low-voltage high performance monolithic FM IF system with high-speed RSSI incorporating a mixer/oscillator, two limiting intermediate frequency amplifiers, quadrature detector, logarithmic received signal strength indicator (RSSI), voltage regulator, wideband data output and fast RSSI op amps. The SA636 is available in 20-lead SOL (surface-mounted small outline large package) and 20-lead SSOP (shrink small outline package).

The SA636 was designed for high bandwidth portable communication applications and will function down to 2.7V. The RF section is similar to the famous NE605. The data output has a minimum bandwidth of 600kHz. This is designed to demodulate wideband data. The RSSI output is amplified. The RSSI output has access to the feedback pin. This enables the designer to adjust the level of the outputs or add filtering.

SA636 incorporates a power down mode which powers down the device when Pin 8 is low. Power down logic levels are CMOS and TTL compatible with high input impedance.

APPLICATIONS

- DECT (Digital European Cordless Telephone)
- Digital cordless telephones
- Digital cellular telephones
- Portable high performance communications receivers
- Single conversion VHF/UHF receivers
- FSK and ASK data receivers
- Wireless LANs

FEATURES

- Wideband data output (600kHz min.)
- Fast RSSI rise and fall times
- Low power consumption: 6.5mA typ at 3V
- Mixer input to >500MHz
- Mixer conversion power gain of 11dB at 240MHz
- Mixer noise figure of 12dB at 240MHz

PIN CONFIGURATION

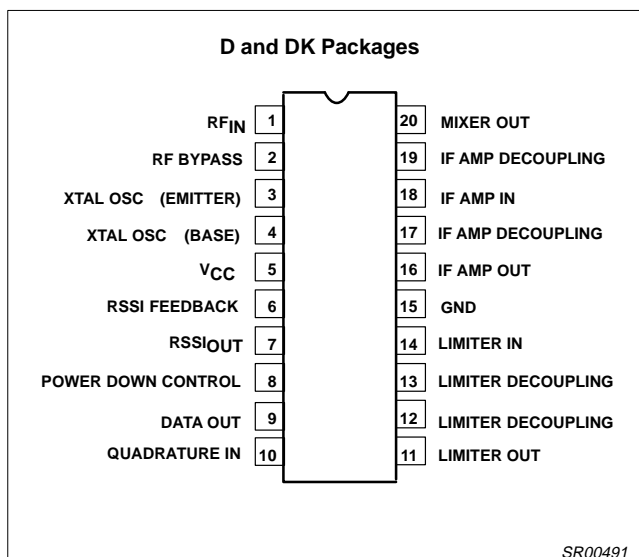

Figure 1. Pin Configuration

- XTAL oscillator effective to 150MHz (L.C. oscillator to 1GHz local oscillator can be injected)
- 92dB of IF Amp/Limiter gain
- 25MHz limiter small signal bandwidth
- Temperature compensated logarithmic Received Signal Strength Indicator (RSSI) with a dynamic range in excess of 90dB
- RSSI output internal op amp
- Internal op amps with rail-to-rail outputs
- Low external component count; suitable for crystal/ceramic/LC filters
- Excellent sensitivity: 0.54µV into 50Ω matching network for 12dB SINAD (Signal to Noise and Distortion ratio) for 1kHz tone with RF at 240MHz and IF at 10.7MHz
- ESD hardened
- 10.7MHz filter matching (330Ω)
- Power down mode ($I_{CC} = 200\mu A$)

ORDERING INFORMATION

DESCRIPTION	TEMPERATURE RANGE	ORDER CODE	DWG #
20-Pin Plastic Small Outline Large (SOL) package (Surface-mount)	-40 to +85°C	SA636D	SOT163-1
20-Pin Plastic Shrink Small Outline Package (Surface-mount)	-40 to +85°C	SA636DK	SOT266-1

Low voltage high performance mixer FM IF system with high-speed RSSI

SA636

BLOCK DIAGRAM

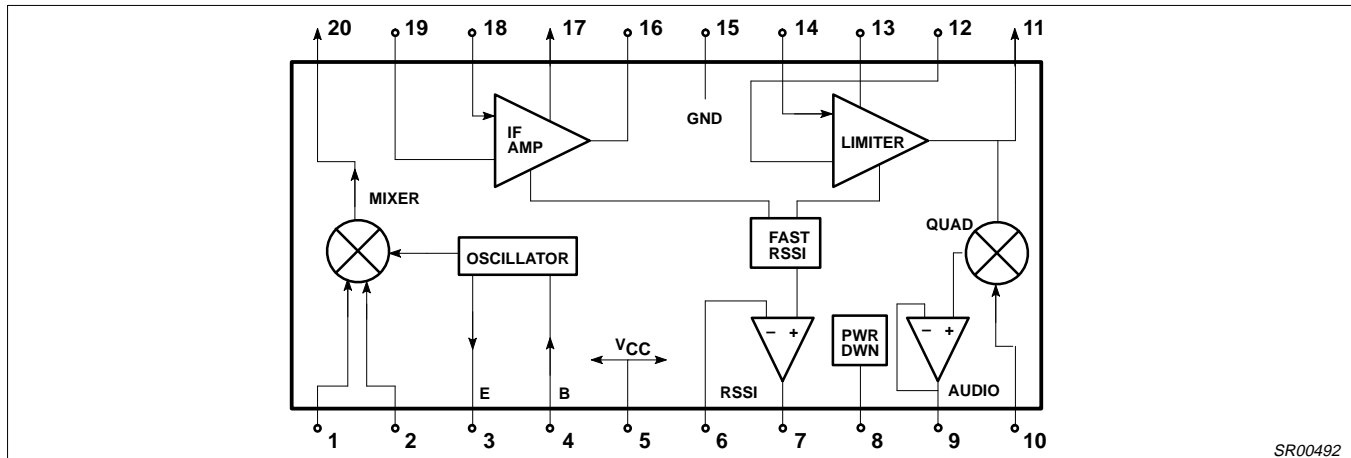

Figure 2. Block Diagram

SR00492

ABSOLUTE MAXIMUM RATINGS

SYMBOL	PARAMETER	RATING	UNITS
V_{CC}	Single supply voltage	0.3 to 7	V
V_{IN}	Voltage applied to any other pin	-0.3 to ($V_{CC}+0.3$)	V
T_{STG}	Storage temperature range	-65 to +150	°C
T_A	Operating ambient temperature range SA636	-40 to +85	°C

NOTE: θ_{JA} , Thermal impedance D package 90°C/W
DK package 117°C/W

DC ELECTRICAL CHARACTERISTICS

$V_{CC} = +3V$, $T_A = 25^\circ C$; unless otherwise stated.

SYMBOL	PARAMETER	TEST CONDITIONS	LIMITS			UNITS
			SA636			
			MIN	TYP	MAX	
V_{CC}	Power supply voltage range		2.7	3.0	5.5	V
I_{CC}	DC current drain	Pin 8 = HIGH	5.5	6.5	7.5	mA
	Input current	Pin 8 LOW	-10		10	μA
		Pin 8 HIGH	-10		10	
	Input level	Pin 8 LOW	0		$0.3V_{CC}$	V
		Pin 8 HIGH	$0.7V_{CC}$		V_{CC}	
I_{CC}	Standby	Pin 8 = LOW		0.2	0.5	mA
t_{ON}	Power up time	RSSI valid (10% to 90%)		10		μs
t_{OFF}	Power down time	RSSI invalid (90% to 10%)		5		μs

Low voltage high performance mixer FM IF system with high-speed RSSI

SA636

AC ELECTRICAL CHARACTERISTICS

$T_A = 25^\circ\text{C}$; $V_{CC} = +3\text{V}$, unless otherwise stated. RF frequency = 240.05MHz + 14.5dBV RF input step-up; IF frequency = 10.7MHz; RF level = -45dBm; FM modulation = 1kHz with $\pm 125\text{kHz}$ peak deviation. Audio output with C-message weighted filter and de-emphasis capacitor. Test circuit Figure 1. The parameters listed below are tested using automatic test equipment to assure consistent electrical characteristics. The limits do not represent the ultimate performance limits of the device. Use of an optimized RF layout will improve many of the listed parameters.

SYMBOL	PARAMETER	TEST CONDITIONS	LIMITS			UNITS
			SA636			
			MIN	TYP	MAX	
Mixer/Osc section (ext LO = 160mV_{RMS})						
f_{IN}	Input signal frequency			500		MHz
f_{OSC}	External oscillator (buffer)			500		MHz
	Noise figure at 240MHz			12		dB
	Third-order input intercept point	Matched $f_1=240.05$; $f_2=240.35\text{MHz}$		-16		dBm
	Conversion power gain	Matched 14.5dBV step-up	8	11	14	dB
	RF input resistance	Single-ended input		700		Ω
	RF input capacitance			3.5		pF
	Mixer output resistance	(Pin 20)		330		Ω
IF section						
	IF amp gain	330 Ω load		38		dB
	Limiter gain	330 Ω load		54		dB
	Input limiting -3dB	Test at Pin 18		-105		dBm
	AM rejection	80% AM 1kHz		50		dB
	Data level	$R_{LOAD} = 100\text{k}\Omega$	100	130		mV _{RMS}
	3dB data bandwidth		600	700		kHz
	SINAD sensitivity	RF level = -111dBm		16		dB
THD	Total harmonic distortion			-43	-38	dB
S/N	Signal-to-noise ratio	No modulation for noise		60		dB
	IF RSSI output with buffer	IF level = -118dBm		0.2	0.5	V
		IF level = -68dBm	0.3	0.6	1.0	V
		IF level = -10dBm	0.9	1.3	1.8	V
	IF RSSI output rise time (10kHz pulse, no 10.7MHz filter) (no RSSI bypass capacitor)	IF frequency = 10.7MHz RF level = -56dBm RF level = -28dBm		1.2		μs
				1.1		μs
	IF RSSI output fall time (10kHz pulse, no 10.7MHz filter) (no RSSI bypass capacitor)	IF frequency = 10.7MHz RF level = -56dBm RF level = -28dBm		2.0		μs
				7.3		μs
	RSSI range			90		dB
	RSSI accuracy			± 1.5		dB
	IF input impedance			330		Ω
	IF output impedance			330		Ω
	Limiter input impedance			330		Ω
	Limiter output impedance			300		Ω
	Limiter output level with no load			130		mV _{RMS}
RF/IF section (int LO)						
	System RSSI output	RF level = -10dBm		1.4		V
	System SINAD	RF level = -106dBm		12		dB

Low voltage high performance mixer FM IF system with high-speed RSSI

SA636

PERFORMANCE CHARACTERISTICS

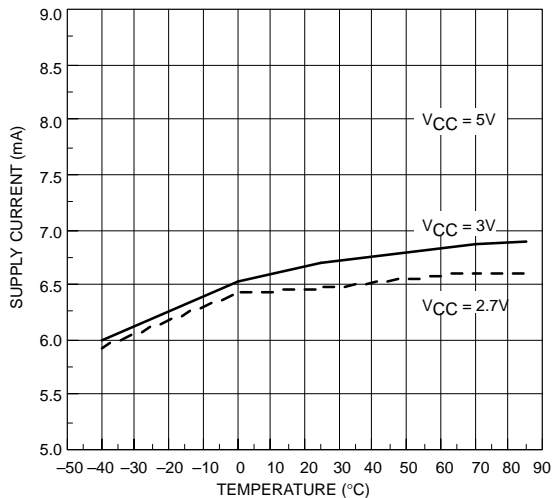

Supply Current vs Temperature and Supply Voltage

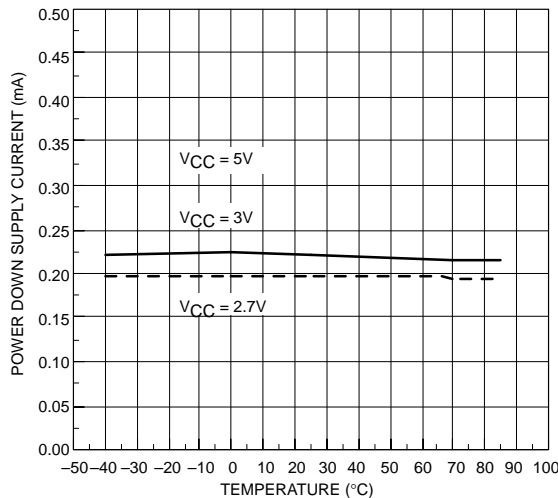

Power Down Supply Current vs Temperature and Supply Voltage

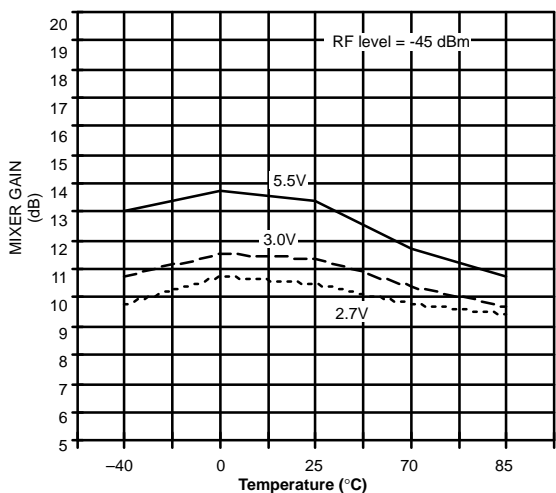

Mixer Power Gain vs Temperature and Supply Voltage

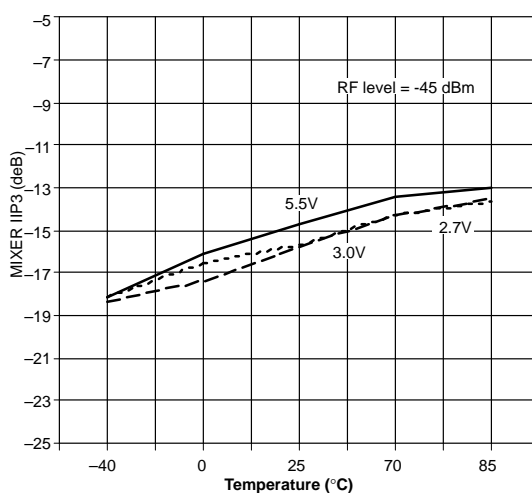

Mixer IIP3 at 240MHz vs Temperature and Supply Voltage

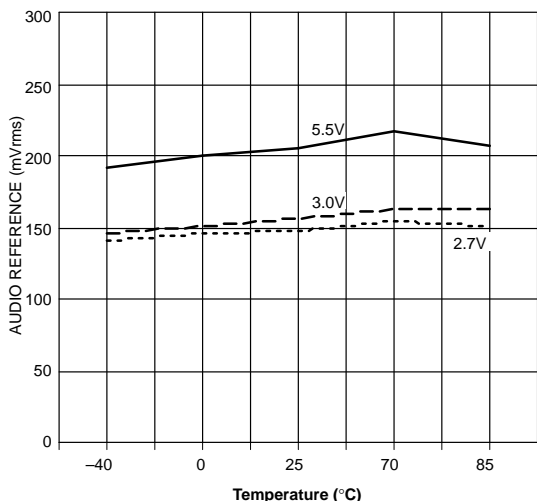

Audio Reference Level vs Temperature and Supply Voltage

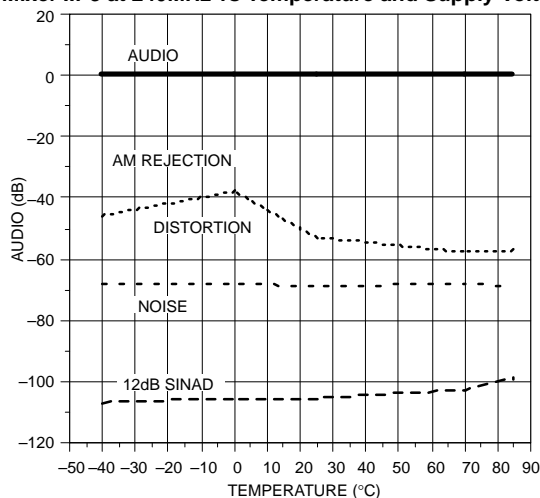

12dB SINAD and Relative Audio, THD, Noise and AM Rejection for VCC = 3V vs Temperature RF = 240MHz, Level = -68dBm, Deviation = 125kHz

SR00493

Figure 3. Performance Characteristics

Low voltage high performance mixer FM IF system with high-speed RSSI

SA636

PERFORMANCE CHARACTERISTICS (continued)

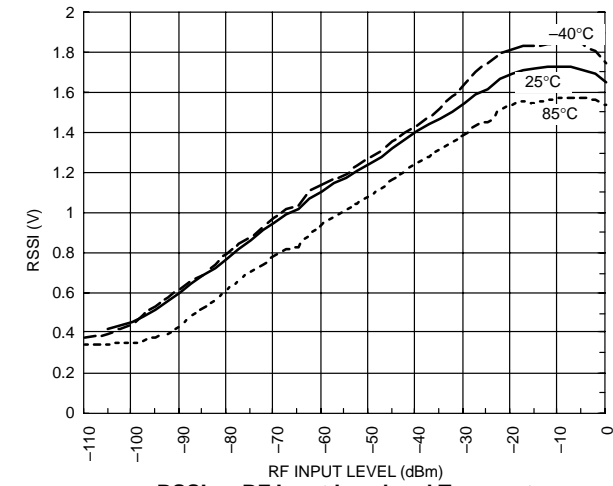
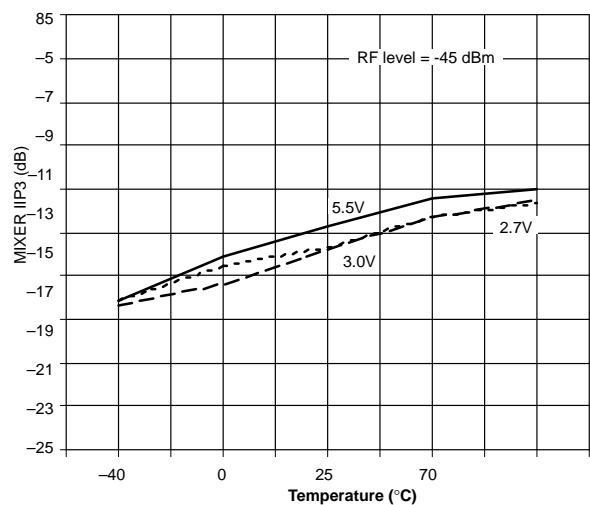
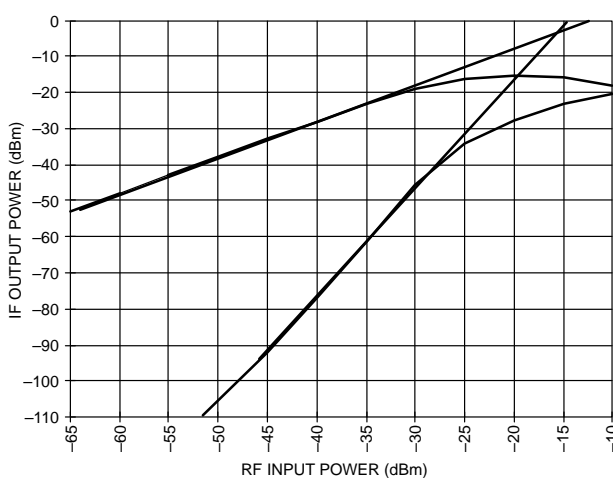
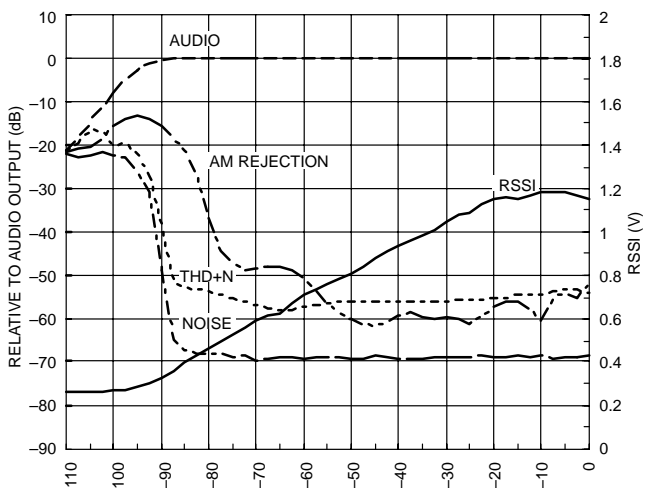
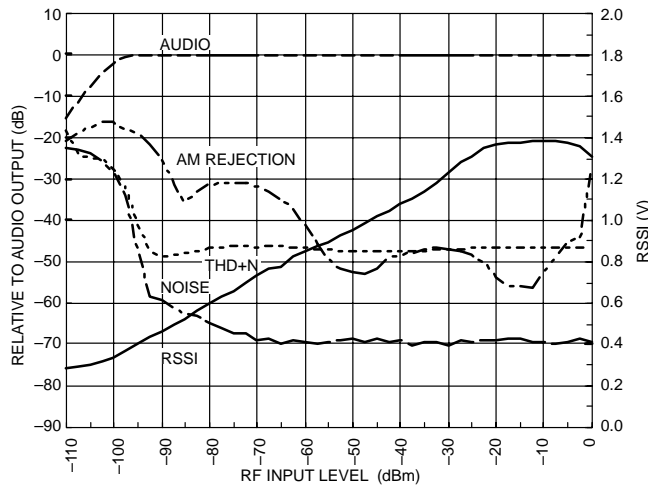
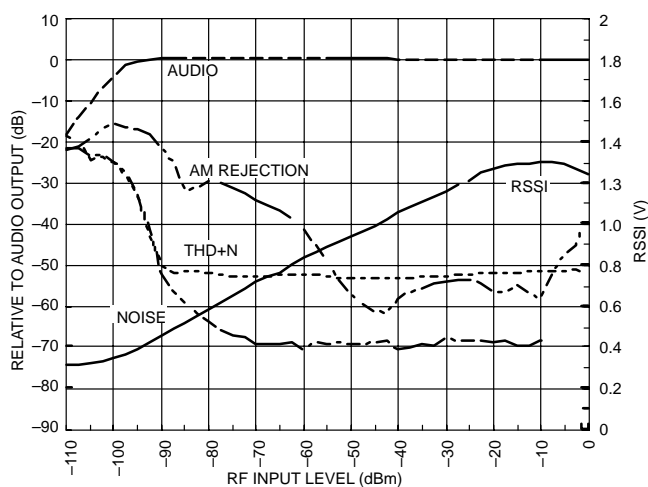

Figure 4. Performance Characteristics

SR00494

Low voltage high performance mixer FM IF system with high-speed RSSI

SA636

PERFORMANCE CHARACTERISTICS (continued)

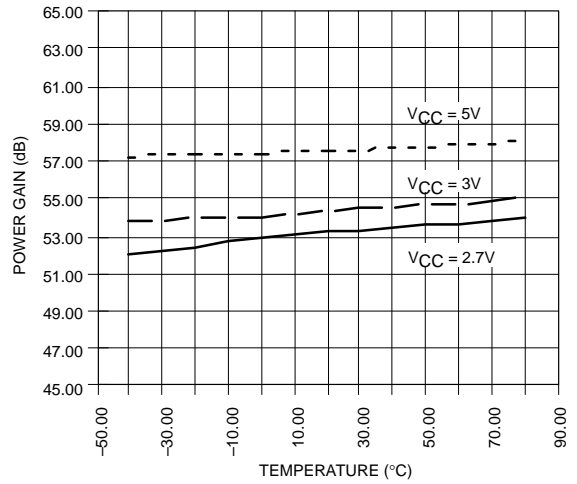
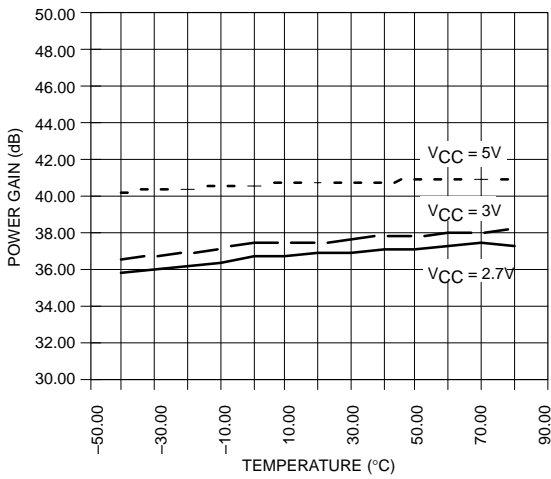

SA626 IF Amplifier Gain vs Temperature vs Supply Voltage

SA626 Limiting Amplifier Gain vs Temperature vs Supply Voltage

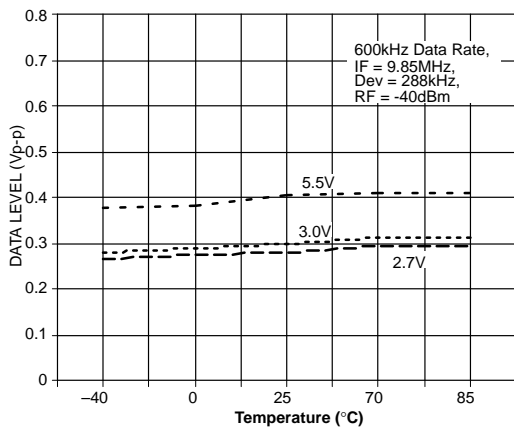

Data Level vs Temperature and Supply Voltage

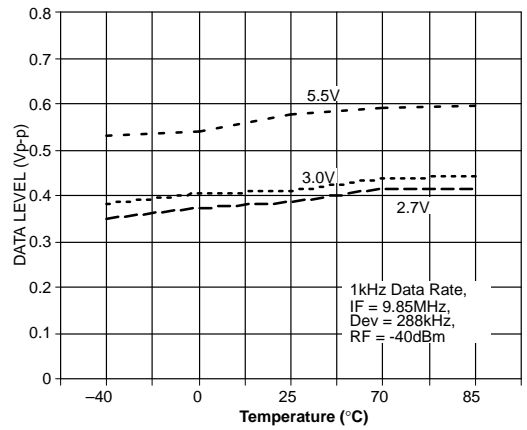

Data Level vs Temperature and Supply Voltage

Figure 5. Performance Characteristics

SR00495

Low voltage high performance mixer FM IF system with high-speed RSSI

SA636

PERFORMANCE CHARACTERISTICS (continued)

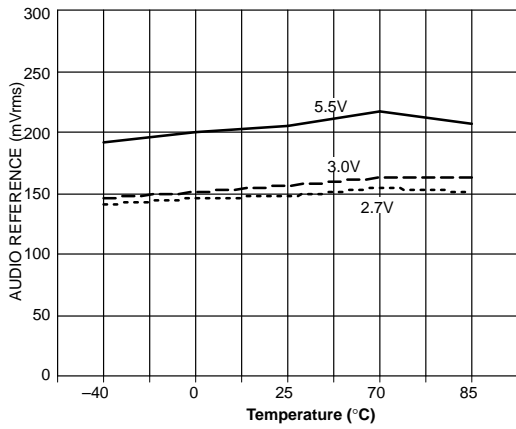

Audio Reference Level vs Temperature and Supply Voltage

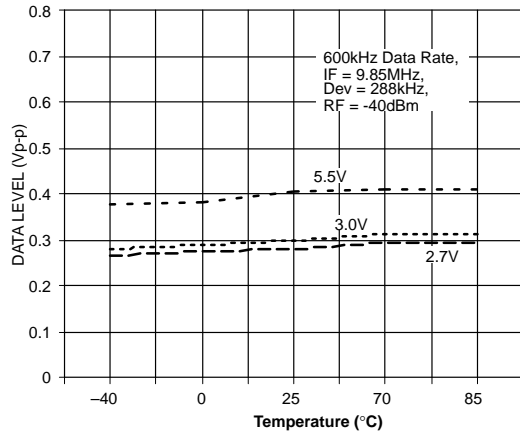

Data Level vs Temperature and Supply Voltage

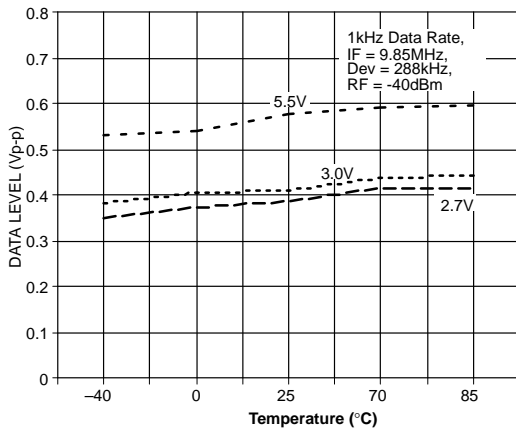

Data Level vs Temperature and Supply Voltage

SR00496

Figure 6. Performance Characteristics

Low voltage high performance mixer FM IF system with high-speed RSSI

SA636

PIN FUNCTIONS

PIN No.	PIN MNEMONIC	DC V	EQUIVALENT CIRCUIT	PIN No.	PIN MNEMONIC	DC V	EQUIVALENT CIRCUIT
1	RF IN	+1.07		6	RSSI FEEDBACK	+0.20	
2	RF BYPASS	+1.07		7	RSSI OUT	+0.20	
3	XTAL OSC	+1.57		8	POWER DOWN	+2.75	
4	XTAL OSC	+2.32		9	DATA OUT	+1.09	
5	VCC	+3.00		10	QUAD. IN	+3.00	

Figure 7. Pin Functions

SR00497

Low voltage high performance mixer FM IF system with high-speed RSSI

SA636

PIN FUNCTIONS (continued)

PIN No.	PIN MNEMONIC	DC V	EQUIVALENT CIRCUIT	PIN No.	PIN MNEMONIC	DC V	EQUIVALENT CIRCUIT
11	LIMITER OUT	+1.35		16	IF AMP OUT	+1.22	
12	LIMITER DECOUP	+1.23		17	IF AMP DECOUP	+1.22	
13	LIMITER COUPLING	+1.23		18	IF AMP IN	+1.22	
14	LIMITER IN	+1.23		19	IF AMP DECOUP	+1.22	
15	GND	0		20	MIXER OUT	+1.03	

Figure 8. Pin Functions (cont.)

SR00498

Low voltage high performance mixer FM IF system with high-speed RSSI

SA636

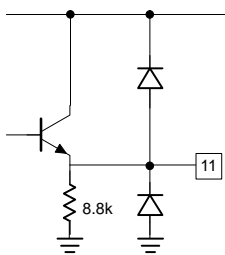
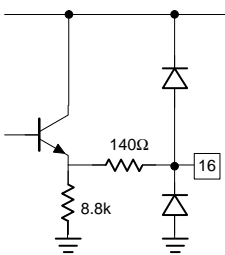
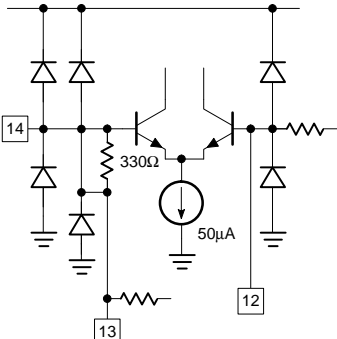
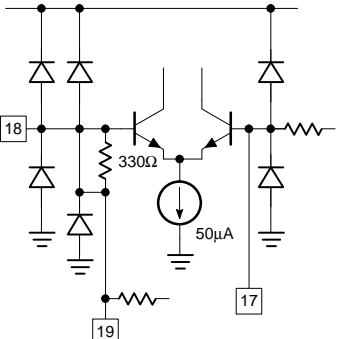
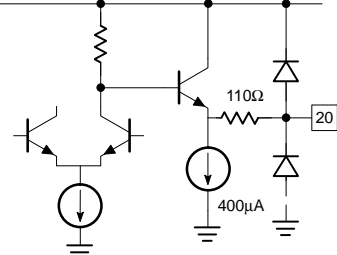
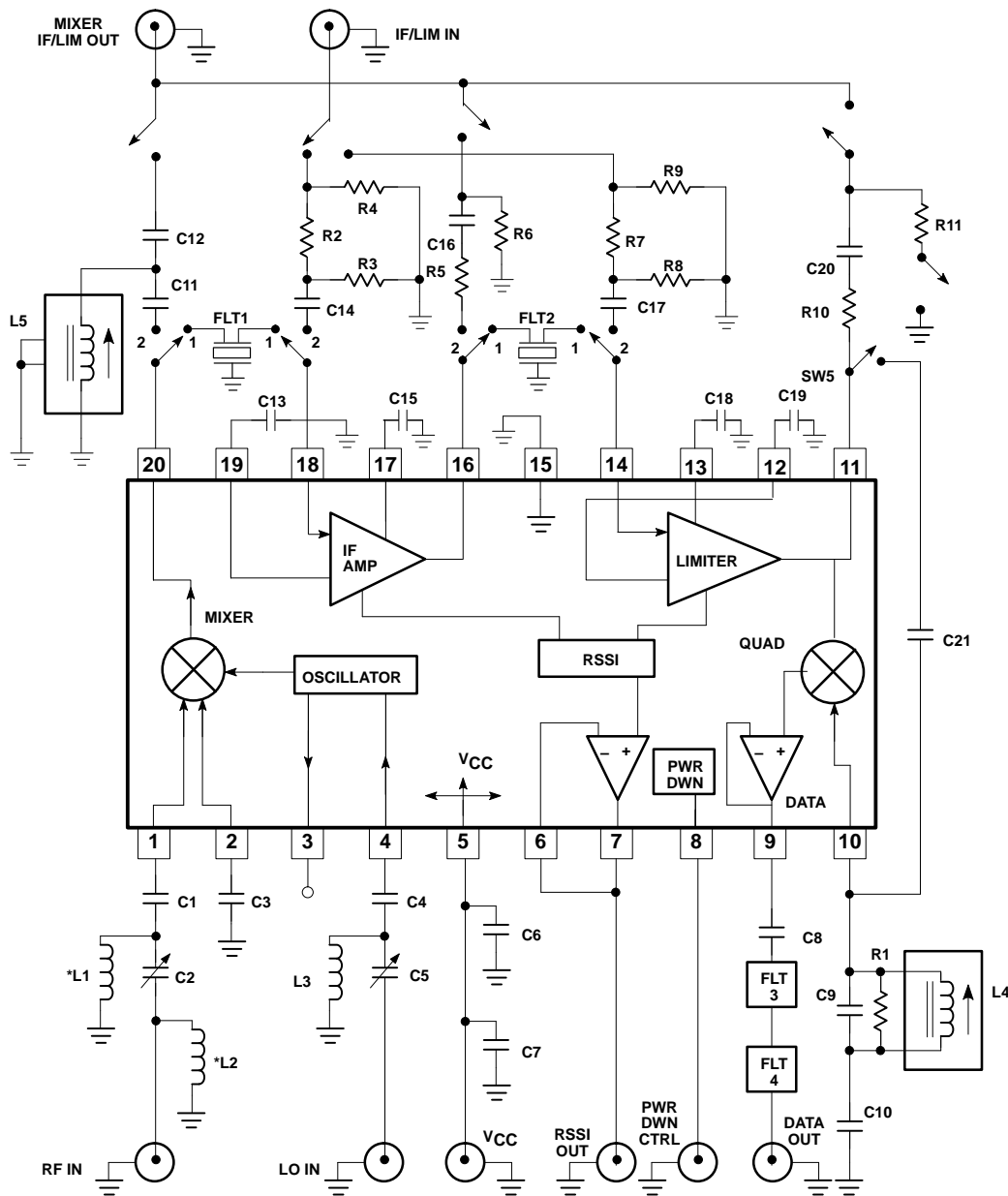

Automatic Test Circuit Component List

R1 8.2kΩ select	C1 0.1μF	C12 160pF select	L1 150nH select for input match
R2 6.42kΩ	C2 1–5pF select for input match	C13 1000pF	L2 22nH select for input match
R3 347.8Ω	C3 0.1μF	C14 0.1μF	L3 47nH select for input match
R4 49.9Ω	C4 0.1μF	C15 1000pF	L4 5.6μH select for input match
R5 1kΩ	C5 1–5pF select for input match	C16 0.1μF	L5 1.27–2.25μH select for mixer output match
R6 49.9Ω	C6 100pF	C17 0.1μF	
R7 6.42kΩ	*C7 6.8μF 10V	C18 1000pF	
R8 347.8Ω	C8 1μF	C19 1000pF	
R9 49.9Ω	C9 39pF select	C20 0.1μF	
R10 1kΩ	C10 0.1μF	C21 1pF	
R11 49.9Ω	C11 0.1μF		
			FLT1 10.7MHz (Murata SFE10.7MA5-A)
			FLT2 10.7MHz (Murata SFE10.7MA5-A)
			FLT3 "C" message weighted
			FLT4 Active de-emphasis

*NOTE: This value can be reduced when a battery is the power source.

SR00501

Figure 9. SA636 240.05MHz (RF) / 10.7MHz (IF) Test Circuit

Low voltage high performance mixer FM IF system with high-speed RSSI

SA636

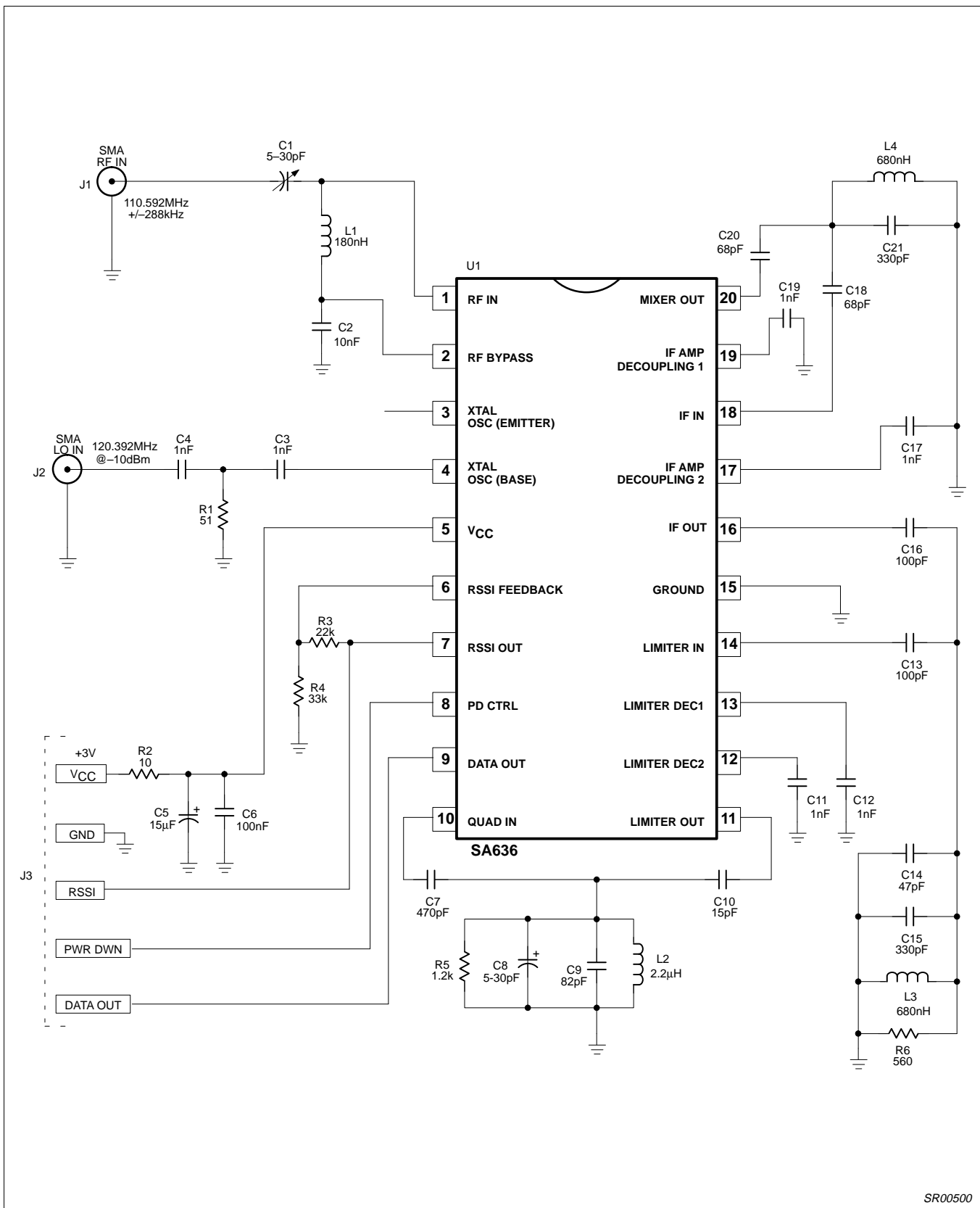

Figure 10. SA636 110.592MHz (RF) / 9.8MHz (IF) DECT Application Circuit

SR00500

Low voltage high performance mixer FM IF system with high-speed RSSI

SA636

Table 1. DECT Application Circuit Electrical Characteristics

RF frequency = 110.592MHz; IF frequency = 9.8MHz; RF level = -45dBm; FM modulation = 100kHz with ±288kHz peak deviation.

SYMBOL	PARAMETER	TEST CONDITIONS	TYPICAL	UNITS
Mixer/Osc section (ext LO = 160mV_{RMS})				
PG	Conversion power gain		13	dB
NF	Noise Figure at 110MHz		12	dB
IIP3	Third order input intercept	Matched f1 = 110.592; f2 = 110.892MHz	-15	dBm
R _{IN}	RF input resistance		690	Ω
C _{IN}	RF input capacitance		3.6	pF
IF section				
	IF amp gain	330Ω load	38	dB
	Limiter amp gain	330Ω load	54	dB
	Data level	R _{LOAD} = 3kΩ	130	mV _{RMS}
	3dB data bandwidth		700	kHz
RF/IF section (internal LO)				
	System RSSI output	RF level = -10dBm	1.4	V
	System S/N ¹	RF level = -83dBm	10	dB

NOTE:

1. 10dB S/N corresponds to BER = 10⁻³.

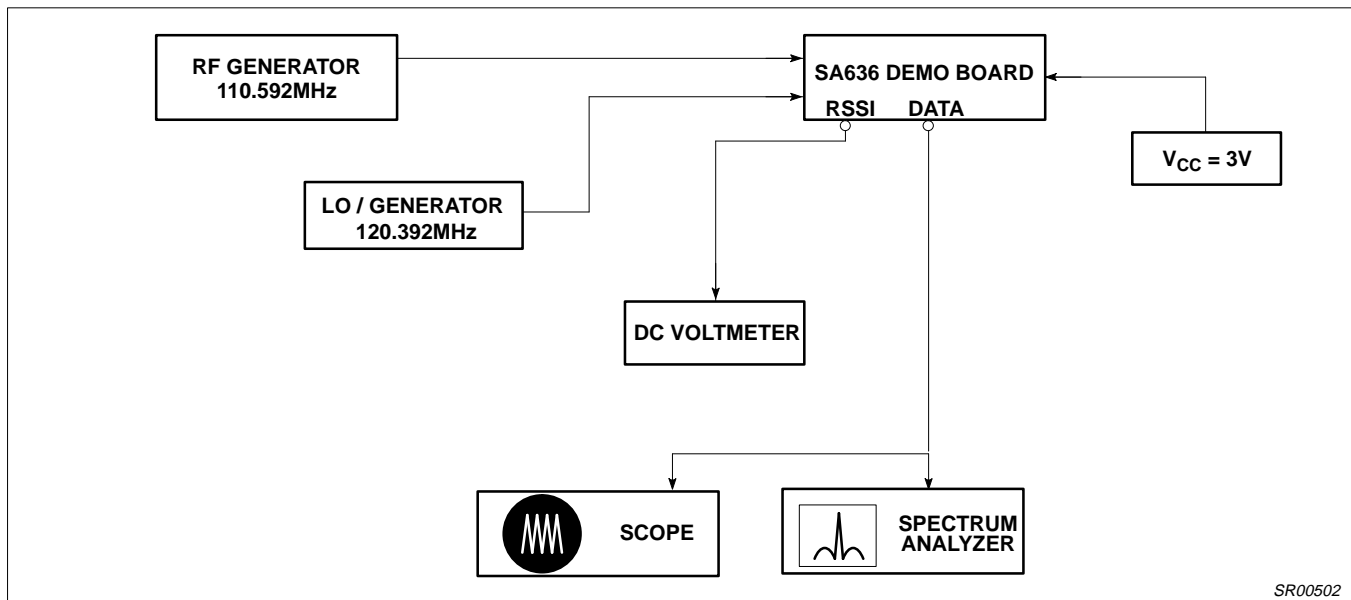

SR00502

Figure 11. SA636 Application Circuit Test Set Up

NOTES:

1. RF generator: Set your RF generator at 110.592MHz, use a 100kHz modulation frequency and a ±288kHz deviation.
2. Layout: The layout is very critical in the performance of the receiver. We highly recommend our demo board layout.
3. RSSI: The smallest RSSI voltage (i.e., when no RF input is present and the input is terminated) is a measure of the quality of the layout and design. If the lowest RSSI voltage is 500mV or higher, it means the receiver is in regenerative mode. In that case, the receiver sensitivity will be worse than expected.
4. Supply bypass and shielding: All of the inductors, the quad tank, and their shield must be grounded. A 0.1µF bypass capacitor on the supply pin improves sensitivity.

Low voltage high performance mixer FM IF system with high-speed RSSI

SA636

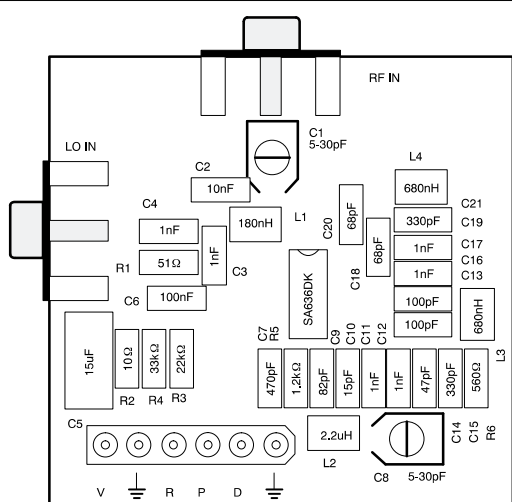

TOP SILK SCREEN (SSOP)

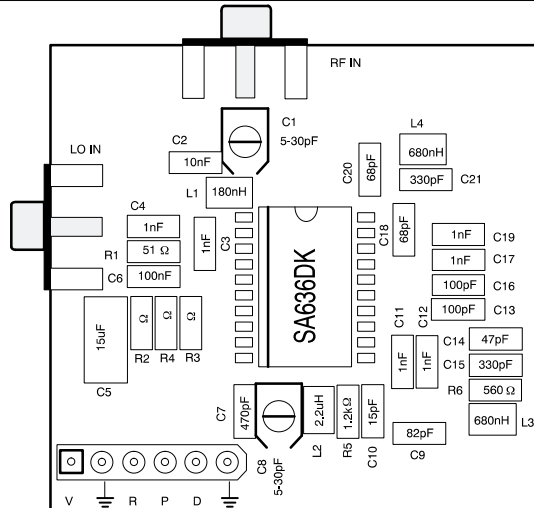

TOP SILK SCREEN (SOL)

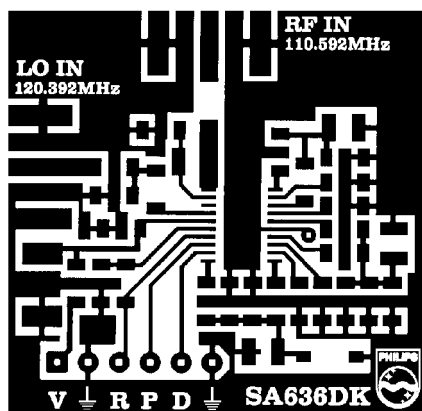

TOP VIEW (SSOP)

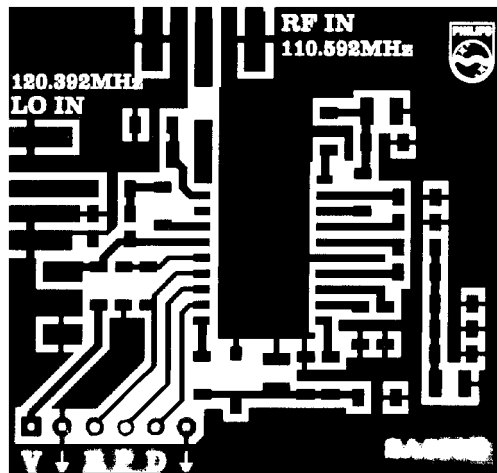

TOP VIEW (SOL)

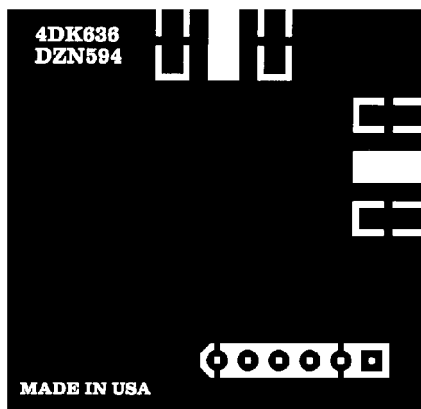

BOTTOM VIEW (SSOP)

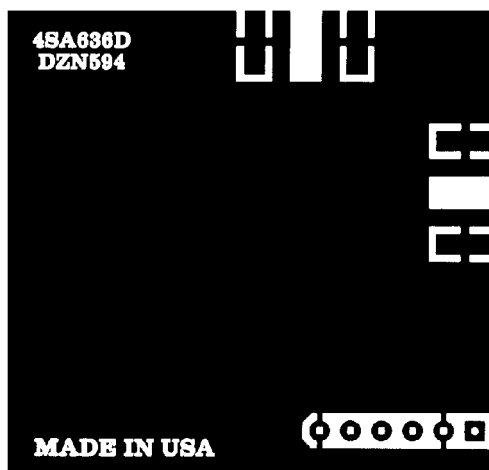

BOTTOM VIEW (SOL)

Figure 12. SA636 Demoboard Layout (Not Actual Size)

Low voltage high performance mixer FM IF system with high-speed RSSI

SA636

CIRCUIT DESCRIPTION

The SA636 is an IF signal processing system suitable for second IF or single conversion systems with input frequency as high as 1GHz. The bandwidth of the IF amplifier is about 40MHz, with 38dB of gain from a 50Ω source. The bandwidth of the limiter is about 28MHz with about 54dB of gain from a 50Ω source. However, the gain/bandwidth distribution is optimized for 10.7MHz, 330Ω source applications. The overall system is well-suited to battery operation as well as high performance and high quality products of all types, such as cordless and cellular hand-held phones.

The input stage is a Gilbert cell mixer with oscillator. Typical mixer characteristics include a noise figure of 14dB, conversion gain of 11dB, and input third-order intercept of -16dBm. The oscillator will operate in excess of 1GHz in L/C tank configurations. Hartley or Colpitts circuits can be used up to 100MHz for xtal configurations. Butler oscillators are recommended for xtal configurations up to 150MHz.

The output of the mixer is internally loaded with a 330Ω resistor permitting direct connection to a 10.7MHz ceramic filter for narrowband applications. The input resistance of the limiting IF amplifiers is also 330Ω. With most 10.7MHz ceramic filters and many crystal filters, no impedance matching network is necessary. For applications requiring wideband IF filtering, such as DECT, external LC filters are used (see Figure 10). To achieve optimum linearity of the log signal strength indicator, there must be a 6dB(v) insertion loss between the first and second IF stages. If the IF filter

or interstage network does not cause 6dB(v) insertion loss, a fixed or variable resistor can be added between the first IF output (Pin 16) and the interstage network.

The signal from the second limiting amplifier goes to a Gilbert cell quadrature detector. One port of the Gilbert cell is internally driven by the IF. The other output of the IF is AC-coupled to a tuned quadrature network. This signal, which now has a 90° phase relationship to the internal signal, drives the other port of the multiplier cell.

Overall, the IF section has a gain of 90dB. For operation at intermediate frequency at 10.7MHz. Special care must be given to layout, termination, and interstage loss to avoid instability.

The demodulated output (DATA) of the quadrature is a voltage output. This output is designed to handle a minimum bandwidth of 600kHz. This is designed to demodulate wideband data, such as in DECT applications.

A Receive Signal Strength Indicator (RSSI) completes the circuitry. The output range is greater than 90dB and is temperature compensated. This log signal strength indicator exceeds the criteria for AMPS or TACS cellular telephone, DECT and RCR-28 cordless telephone. This signal drives an internal op amp. The op amp is capable of rail-to-rail output. It can be used for gain, filtering, or 2nd-order temperature compensation of the RSSI, if needed.

NOTE: $\text{dB(v)} = 20\log V_{\text{OUT}}/V_{\text{IN}}$