

Silicon Bipolar MMIC 2.5 GHz Variable Gain Amplifier

Technical Data

IVA-14208
IVA-14228

Features

- **Differential Input and Output Capability**
- **DC to 2.5 GHz Bandwidth; 3.4 Gbits/s Data Rates**
- **High Gain:** 24 dB Typical
- **Wide Gain Control Range:** 34 dB Typical
- **6 V Bias**
- **5 V V_{GC} Control Range, $I_{GC} < 3\text{ mA}$**
- **Fast Gain Response:** $< 10\text{ nsec}$ Typical
- **IVA-14208:** Low Cost Plastic Surface Mount Package
- **IVA-14228:** Hermetic Ceramic Surface Mount Package

Description

The IVA-14 series MMICs are variable gain amplifiers. The IVA-14208 is housed in a miniature low cost plastic surface mount package. The IVA-14228 is housed in a miniature hermetic ceramic surface mount package. Both devices can be used in any combination of single-ended or differential inputs or outputs (see Functional Block Diagram). The lowest frequency of operation is limited only by the values of user selected blocking and bypass capacitors.

Typical applications include variable gain amplification or limiting for fiber optic systems (e.g. SONET) with data rates up to 3.4 Gbits/s, mobile radio and satellite receivers, millimeter wave receiver IF amplifiers and communications receivers.

The IVA series of variable gain amplifiers is fabricated using Hewlett-Packard's 10 GHz f_T , 25 GHz f_{MAX} ISOSAT™-1 silicon bipolar process. This process uses nitride self-alignment, sub-micrometer lithography, trench isolation, ion implantation, gold metallization and polyimide inter-metal dielectric and scratch protection to achieve excellent performance, uniformity and reliability.

IVA-14208

Plastic SO-8 Package

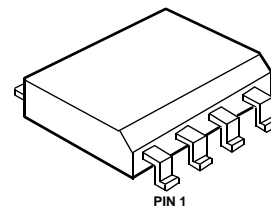

IVA-14228

Ceramic '28' Package

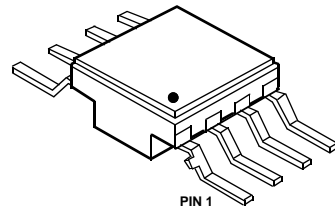

Functional Block Diagram and Pin Configuration

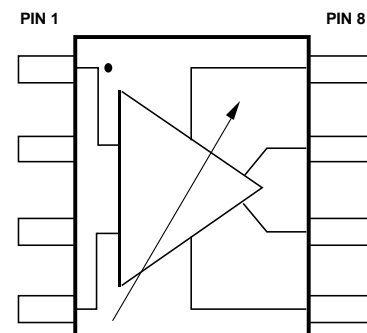

PIN DESCRIPTION	
1. INPUT +	8. V_{GC}
2. V_{EE} , AC GROUND	7. OUTPUT +
3. V_{EE} , AC GROUND	6. OUTPUT -
4. INPUT -	5. V_{CC}

IVA-14228 PACKAGE BOTTOM IS V_{EE} AC GROUND.

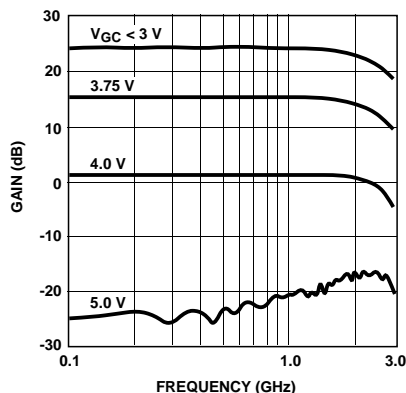

Figure 1. IVA-14228 Typical Variable Gain vs. Frequency and V_{GC} at $V_{CC} = 6\text{ V}$, $T_{case} = 25^\circ\text{C}$.

IVA-14208, -14228 Absolute Maximum Ratings^[1]

Symbol	Parameter	Units	IVA-14208	IVA-14228
$V_{CC}-V_{EE}$	Device Voltage, $T_{case} = 25^{\circ}C$	Volts	12	12
P_{in}	Input Power, $T_{case} = 25^{\circ}C$	dBm	13	13
$V_{GC}-V_{EE}$	Control Voltage, $T_{case} = 25^{\circ}C$	Volts	10	10
T_j	Junction Temperature +	$^{\circ}C$	150	200
T_{stg}	Storage Temperature	$^{\circ}C$	-65 to +150	-65 to +200
P_t	Total Device Dissipation	mW	1000 ^[2]	1000 ^[3]

Thermal Resistance:

IVA-14208 Thermal Resistance Junction to Case ^[4] : $\theta_{jc} = 68^{\circ}C/W$ IVA-14228 Thermal Resistance Junction to Case ^[4] : $\theta_{jc} = 63^{\circ}C/W$
--

Notes:

1. Operation in excess of any one of these conditions may result in permanent damage to the device.
2. $T_{case} = 25^{\circ}C$. Derate at 14.7 mW/ $^{\circ}C$ for $T_{case} > 82^{\circ}C$.
3. $T_{case} = 25^{\circ}C$. Derate at 15.9 mW/ $^{\circ}C$ for $T_{case} > 137^{\circ}C$.
4. $T_j = 150^{\circ}C$.

IVA-14208, -14228 Guaranteed Electrical Specifications

All measurements reflect single-ended (unbalanced) performance. $T_{case} = 25^{\circ}C$. $V_{CC} = 6V$, $V_{EE} = 0V$, $V_{GC} = 0V$, $Z_L = 50\Omega$

Symbol	Parameter	Units	IVA-14208			IVA-14228		
			Min.	Typ.	Max.	Min.	Typ.	Max.
GP	Power Gain ($ S_{21} ^2$), $f = 1\text{ GHz}$	dB	20	24		22	24	
ΔGP	Gain Flatness, $f = 0.05\text{ to }2\text{ GHz}$	dB		± 12			± 0.7	
f_{3dB}	3 dB Bandwidth	GHz	2.0	2.5		2.2	2.5	
GCR	Gain Control Range ^[2] , $f = 1\text{ GHz}$, $V_{GC} = 0\text{ to }5\text{ V}$	dB	30	34		30	34	
ISO	Reverse Isolation ($ S_{12} ^2$), $f = 1\text{ GHz}$, $V_{GC} = 0\text{ to }5\text{ V}$	dB		37			40	
VSWR	Input VSWR, $f = 0.05\text{ to }2.0\text{ GHz}$, $V_{GC} = 0\text{ to }5\text{ V}$			2:1			2:1	
	Output VSWR, $f = 0.05\text{ to }2.0\text{ GHz}$, $V_{GC} = 0\text{ to }5\text{ V}$			2:1			2.5:1	
NF	50 Ω Noise Figure, $f = 1\text{ GHz}$	dB		9.0			9.0	
P_{1dB}	Output Power at 1 dB Gain, Compression $f = 1\text{ GHz}$	dBm		-2.0			-2.0	
V_{OUT}	Pk-Pk Single-ended Output Voltage, $f = 1\text{ GHz}$	mVpp		450			450	
IP_3	Third Order Intercept Point, $f = 1\text{ GHz}$	dBm		8			8	
t_D	Group Delay, $f = 1\text{ GHz}$	psec		450			450	
I_{cc}	Supply Current	mA	28	38	48	28	38	48

Notes:

1. The recommended operating voltage range for these devices is 5 to 8 V. Typical performance as a function of voltage is shown in the graphs on the following pages.
2. The recommended gain control range for these devices for dynamic control is 0 to 4.2 V. Operation at gain control settings above 4.2 V may result in gain control increase rather than gain decrease. See figures 4 and 19.

IVA-14228 Typical Performance Curves

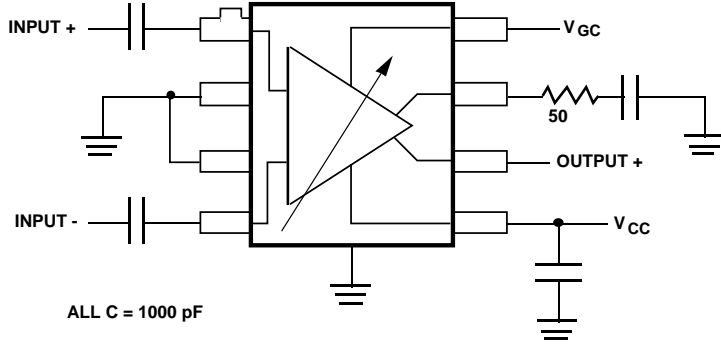

Figure 2. IVA-142X8 Connection Diagram Showing Balanced Inputs and Unbalanced Outputs. Inputs and Outputs May Be Either Balanced or Unbalanced.

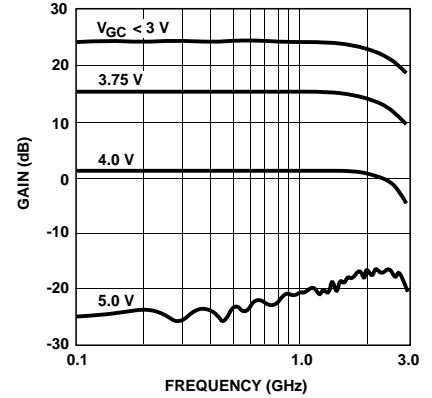

Figure 3. IVA-14228 Gain vs. Frequency and V_{GC} ; $V_{CC} = 6\text{ V}$, $T_{case} = 25^\circ\text{C}$.

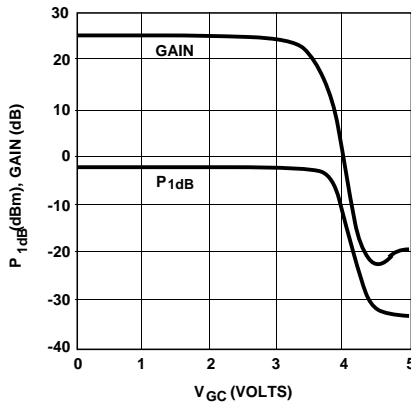

Figure 4. IVA-14228 P_{1dB} and Gain vs. V_{GC} ; $V_{CC} = 6\text{ V}$, $T_{case} = 25^\circ\text{C}$.

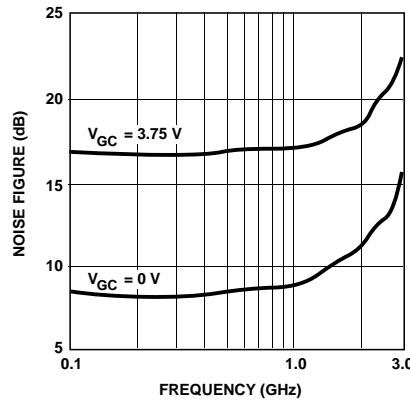

Figure 5. IVA-14228 Noise Figure vs. Frequency and V_{GC} ; $V_{CC} = 6\text{ V}$, $T_{case} = 25^\circ\text{C}$.

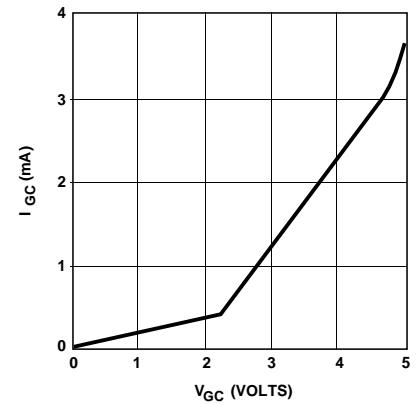

Figure 6. IVA-14228 I_{GC} vs. V_{GC} ; $V_{CC} = 6\text{ V}$, $T_{case} = 25^\circ\text{C}$.

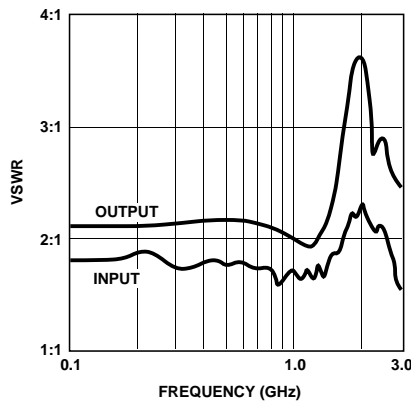

Figure 7. IVA-14228 VSWR vs. Frequency; $V_{CC} = 6\text{ V}$, $V_{GC} = 0\text{ V}$, $T_{case} = 25^\circ\text{C}$.

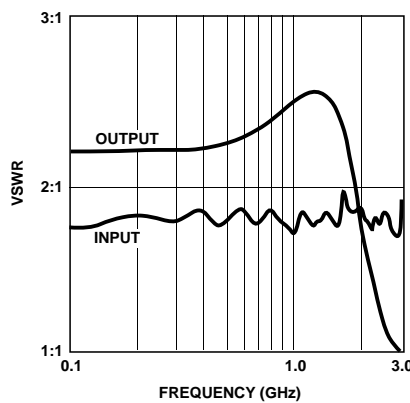

Figure 8. IVA-14228 VSWR vs. Frequency; $V_{CC} = 6\text{ V}$, $V_{GC} = 5\text{ V}$, $T_{case} = 25^\circ\text{C}$.

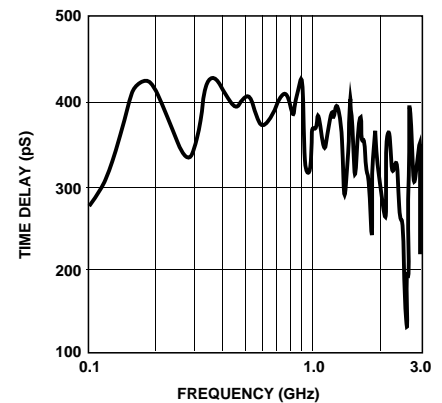

Figure 9. IVA-14228 Group Delay vs. Frequency; $V_{GC} = 0\text{ V}$, $V_{CC} = 6\text{ V}$, $T_{case} = 25^\circ\text{C}$.

IVA-14228 Typical Performance Curves (cont.)

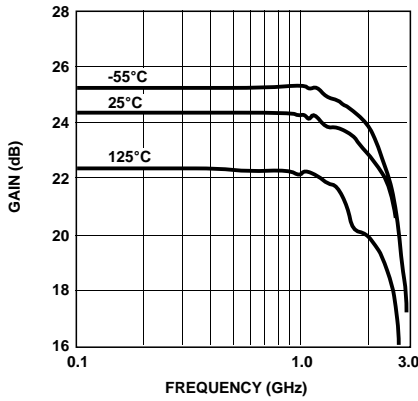

Figure 10. IVA-14228 Gain vs. Frequency and Temperature; $V_{CC} = 6\text{ V}$, $V_{GC} = 0\text{ V}$.

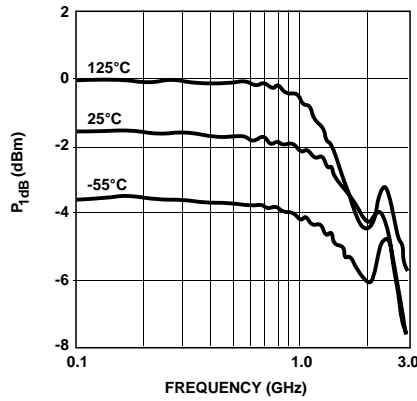

Figure 11: IVA-14228 P_{1dB} vs. Frequency and Temperature; $V_{CC} = 6\text{ V}$, $V_{GC} = 0\text{ V}$.

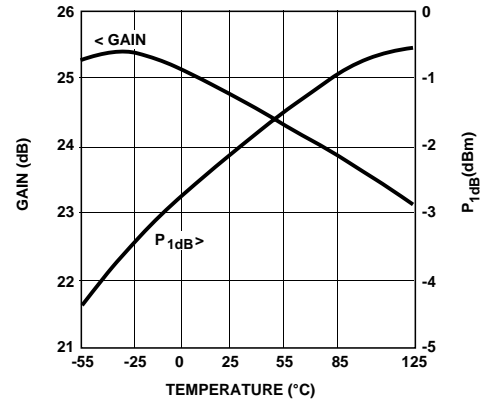

Figure 12. IVA-14228 Gain and P_{1dB} vs. Temperature; $V_{CC} = 6\text{ V}$, $V_{GC} = 0\text{ V}$, Frequency = 1 GHz.

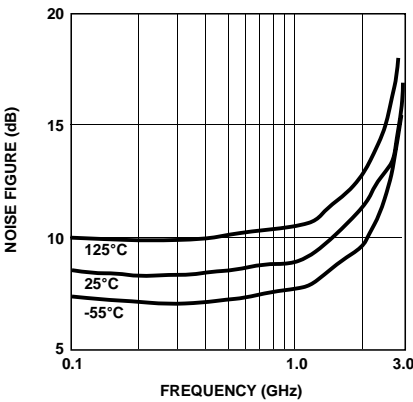

Figure 13. IVA-14228 Noise Figure vs. Frequency and Temperature; $V_{CC} = 6\text{ V}$, $V_{GC} = 0\text{ V}$.

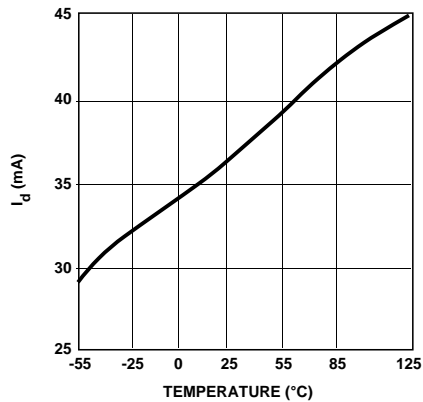

Figure 14. IVA-14228 I_{CC} vs. Temperature; $V_{CC} = 6\text{ V}$, $V_{GC} = 0\text{ V}$, Frequency = 1 GHz.

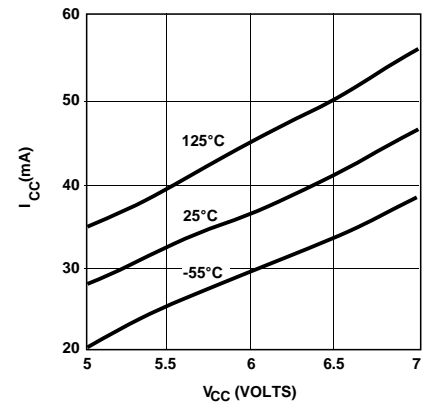

Figure 15. IVA-14228 I_{CC} vs. V_{CC} and Temperature; $V_{GC} = 0\text{ V}$.

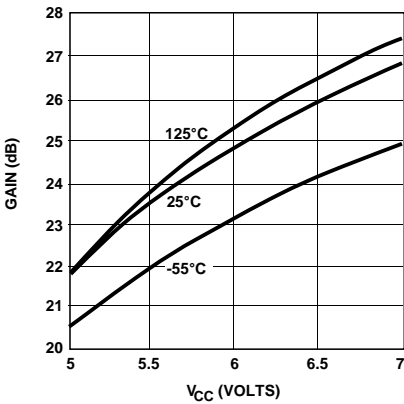

Figure 16. IVA-14228 Gain vs. V_{CC} and Temperature; $V_{GC} = 0\text{ V}$, Frequency = 1 GHz.

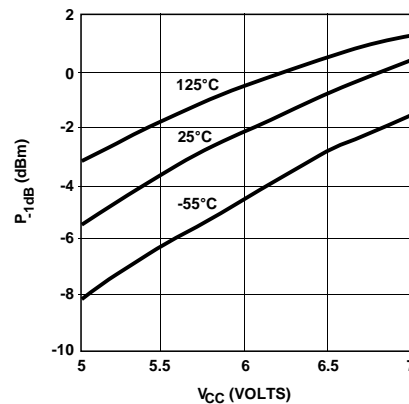

Figure 17. IVA-14228 P_{1dB} vs. V_{CC} and Temperature; $V_{GC} = 0\text{ V}$, Frequency = 1 GHz.

IVA-14208 Typical Performance Curves

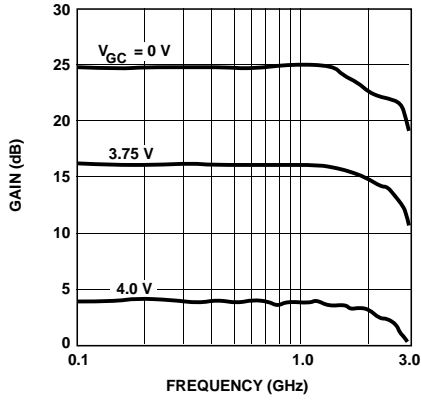

Figure 18. IVA-14208 Gain vs. Frequency and V_{GC} ; $V_{CC} = 6\text{ V}$, $T_{case} = 25\text{ }^{\circ}\text{C}$.

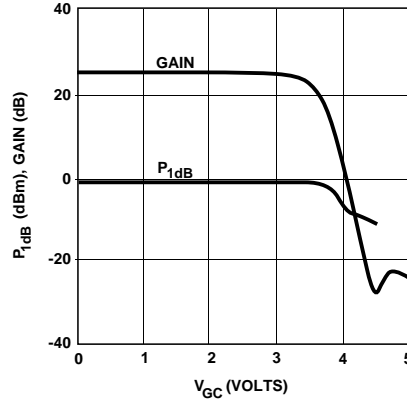

Figure 19. IVA-14208 Gain and P_{1dB} vs. V_{GC} ; $V_{CC} = 6\text{ V}$, Frequency = 1 GHz, $T_{case} = 25\text{ }^{\circ}\text{C}$.

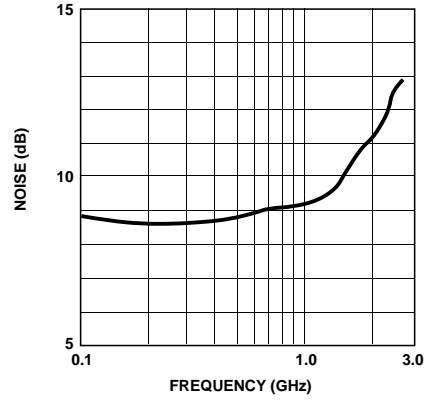

Figure 20. IVA-14208 Noise Figure vs. Frequency; $V_{CC} = 6\text{ V}$, $V_{GC} = 0\text{ V}$, $T_{case} = 25\text{ }^{\circ}\text{C}$.

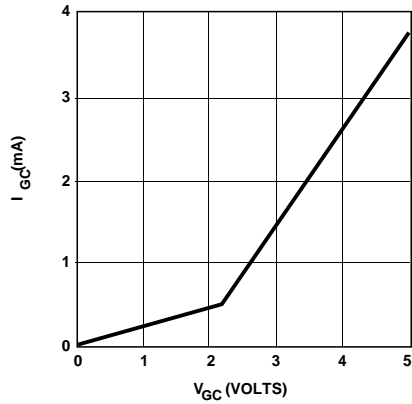

Figure 21. IVA-14208 I_{GC} vs. V_{GC} ; $V_{CC} = 6\text{ V}$, $T_{case} = 25\text{ }^{\circ}\text{C}$.

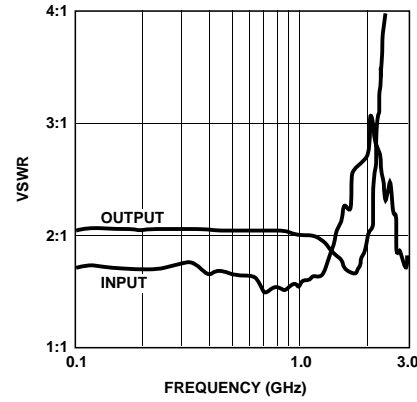

Figure 22. IVA-14208 VSWR vs. Frequency; $V_{CC} = 6\text{ V}$, $V_{GC} = 0\text{ V}$, $T_{case} = 25\text{ }^{\circ}\text{C}$.

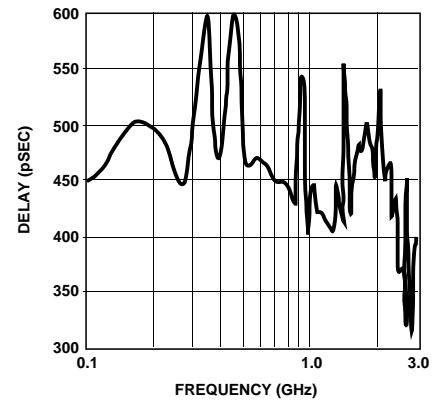

Figure 23. IVA-14208 Group Delay vs. Frequency; $V_{CC} = 6\text{ V}$, $V_{GC} = 0\text{ V}$, $T_{case} = 25\text{ }^{\circ}\text{C}$.

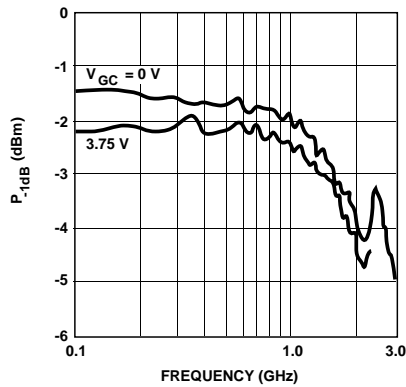

Figure 24. IVA-14208 P_{1dB} vs. Frequency and V_{GC} ; $V_{CC} = 6\text{ V}$, Frequency = 1 GHz, $T_{case} = 25\text{ }^{\circ}\text{C}$.

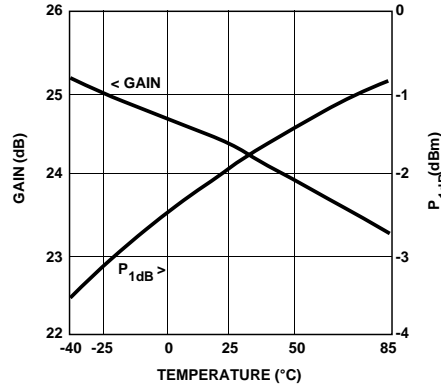

Figure 25. IVA-14208 Gain and P_{1dB} vs. Temperature; $V_{CC} = 6\text{ V}$, $V_{GC} = 0\text{ V}$, Frequency = 1 GHz.

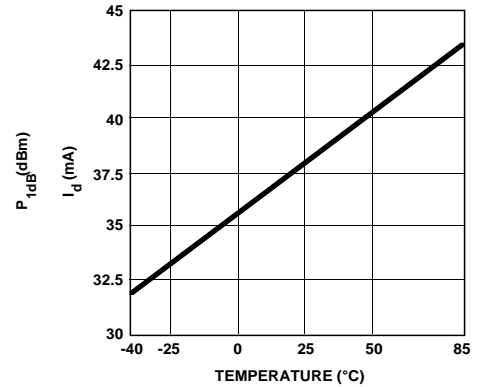

Figure 26. IVA-14208 I_{GC} vs. Temperature; $V_{CC} = 6\text{ V}$, $V_{GC} = 0\text{ V}$.

IVA-14208 Typical Performance Curves (cont.)

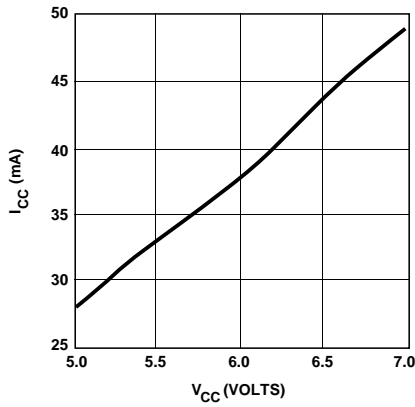

Figure 27. IVA-14208 I_{CC} vs. V_{CC}; V_{GC} = 0 V, T_{case} = 25 °C.

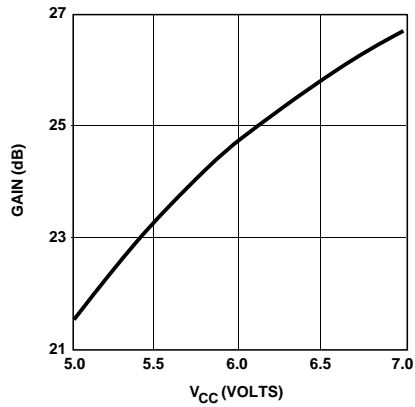

Figure 28. IVA-14208 Gain vs. V_{CC}; V_{GC} = 0 V, Frequency = 1 GHz, T_{case} = 25 °C.

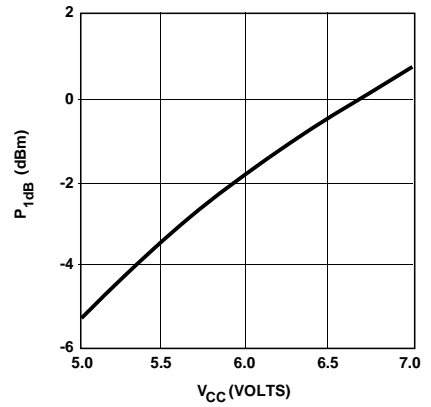

Figure 29. IVA-14208 P_{1dB} vs. V_{CC}; V_{GC} = 0 V, Frequency = 1 GHz, T_{case} = 25 °C.

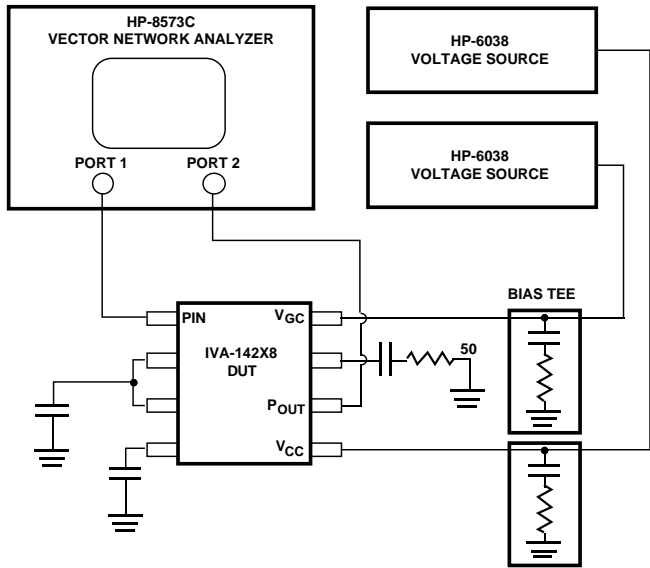
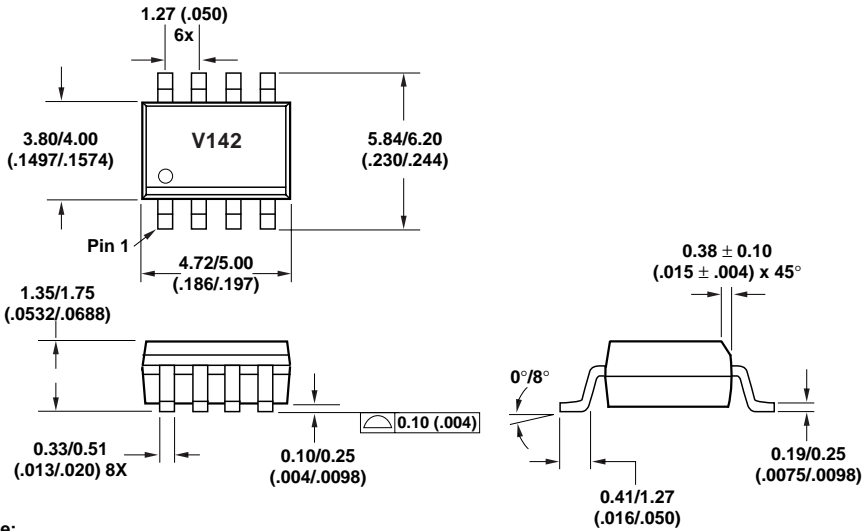

Figure 30. Test Equipment Setup for Measuring Performance of the IVA-142X8.

IVA-14208, -14228 Part Number Ordering Information

Part Number	Container Type	Qty. per Container
IVA-14208-STR	BIP Strip	1
IVA-14208-TR1	7" Reel	1000
IVA-14228-STR	BIP Strip	1

SO-8 Package Dimensions for IVA-14208



Note:

1. Dimensions are shown in millimeters (inches).

28 Package Dimensions for IVA-14228

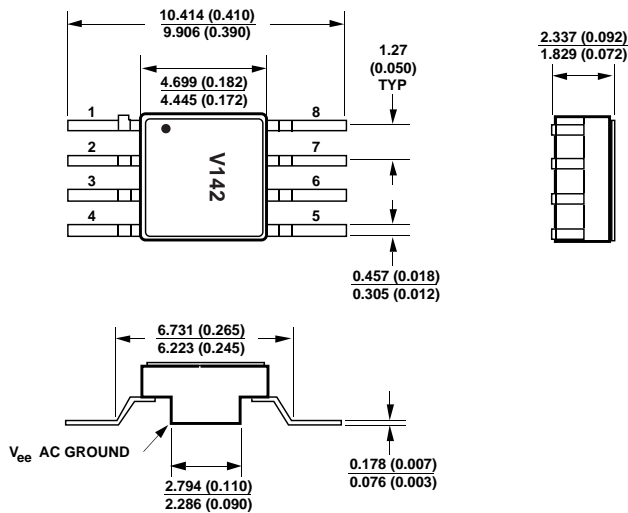

NOTES:

1. DIMENSIONS ARE IN MILLIMETERS (INCHES).
2. CONTROLLING DIMENSIONS ARE IN INCHES.