

# Cascadable Silicon Bipolar MMIC Amplifier

## Technical Data

### MSA-0386

#### Features

- **Cascadable 50 Ω Gain Block**
- **3 dB Bandwidth:**  
DC to 2.4 GHz
- **12.0 dB Typical Gain at  
1.0 GHz**
- **10.0 dBm Typical P<sub>1 dB</sub> at  
1.0 GHz**
- **Unconditionally Stable  
(k>1)**
- **Surface Mount Plastic  
Package**
- **Tape-and-Reel Packaging  
Option Available<sup>[1]</sup>**

#### Note:

1. Refer to PACKAGING section "Tape-and-Reel Packaging for Surface Mount Semiconductors".

#### Description

The MSA-0386 is a high performance silicon bipolar Monolithic Microwave Integrated Circuit (MMIC) housed in a low cost, surface mount plastic package. This MMIC is designed for use as a general purpose 50 Ω gain block. Typical applications include narrow and broad band IF and RF amplifiers in commercial and industrial applications.

The MSA-series is fabricated using HP's 10 GHz  $f_T$ , 25 GHz  $f_{MAX}$ , silicon bipolar MMIC process which uses nitride self-alignment, ion implantation, and gold metallization to achieve excellent performance, uniformity and reliability. The use of an external bias resistor for temperature and current stability also allows bias flexibility.

#### 86 Plastic Package

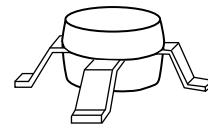

#### Typical Biasing Configuration

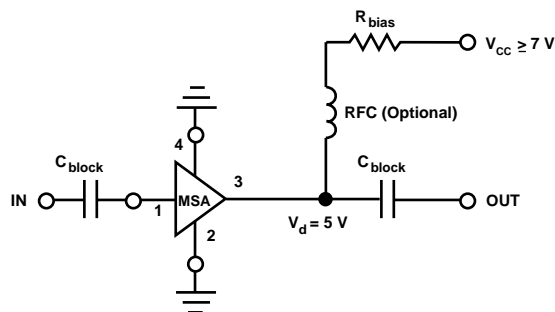

## MSA-0386 Absolute Maximum Ratings

Parameter	Absolute Maximum <sup>[1]</sup>
Device Current	70 mA
Power Dissipation <sup>[2,3]</sup>	400 mW
RF Input Power	+13 dBm
Junction Temperature	150°C
Storage Temperature	-65 to 150°C

### Thermal Resistance<sup>[2,4]</sup>:

$$\theta_{jc} = 115^{\circ}\text{C/W}$$

#### Notes:

1. Permanent damage may occur if any of these limits are exceeded.
2.  $T_{\text{CASE}} = 25^{\circ}\text{C}$ .
3. Derate at 9.5 mW/°C for  $T_{\text{C}} > 116^{\circ}\text{C}$ .
4. See MEASUREMENTS section "Thermal Resistance" for more information.

## Electrical Specifications<sup>[1]</sup>, $T_{\text{A}} = 25^{\circ}\text{C}$

Symbol	Parameters and Test Conditions: $I_{\text{d}} = 35 \text{ mA}$ , $Z_0 = 50 \Omega$	Units	Min.	Typ.	Max.
$G_{\text{P}}$	Power Gain ( $ S_{21} ^2$ ) f = 0.1 GHz f = 1.0 GHz	dB	10.0	12.5 12.0	
$\Delta G_{\text{P}}$	Gain Flatness f = 0.1 to 1.6 GHz	dB		$\pm 0.7$	
$f_{3 \text{ dB}}$	3 dB Bandwidth	GHz		2.4	
VSWR	Input VSWR f = 0.1 to 3.0 GHz			1.5:1	
	Output VSWR f = 0.1 to 3.0 GHz			1.7:1	
NF	50 $\Omega$ Noise Figure f = 1.0 GHz	dB		6.0	
$P_{1 \text{ dB}}$	Output Power at 1 dB Gain Compression f = 1.0 GHz	dBm		10.0	
$\text{IP}_3$	Third Order Intercept Point f = 1.0 GHz	dBm		23.0	
$t_{\text{D}}$	Group Delay f = 1.0 GHz	psec		140	
$V_{\text{d}}$	Device Voltage	V	4.0	5.0	6.0
dV/dT	Device Voltage Temperature Coefficient	mV/°C		-8.0	

#### Note:

1. The recommended operating current range for this device is 20 to 40 mA. Typical performance as a function of current is on the following page.

## Part Number Ordering Information

Part Number	No. of Devices	Container
MSA-0386-TR1	1000	7" Reel
MSA-0386-BLK	100	Antistatic Bag

For more information, see "Tape and Reel Packaging for Semiconductor Devices".

### MSA-0386 Typical Scattering Parameters ( $Z_0 = 50 \Omega$ , $T_A = 25^\circ\text{C}$ , $I_d = 35 \text{ mA}$ )

Freq. GHz	$S_{11}$		$S_{21}$			$S_{12}$			$S_{22}$	
	Mag	Ang	dB	Mag	Ang	dB	Mag	Ang	Mag	Ang
0.1	.11	174	12.5	4.22	175	-18.3	.122	1	.13	-11
0.2	.11	169	12.5	4.20	170	-18.2	.124	2	.13	-20
0.4	.11	159	12.4	4.16	159	-18.1	.124	5	.14	-41
0.6	.10	149	12.2	4.09	149	-17.9	.128	8	.15	-60
0.8	.10	142	12.1	4.00	139	-17.6	.131	9	.16	-78
1.0	.09	137	11.9	3.93	129	-17.4	.136	11	.18	-93
1.5	.09	139	11.2	3.61	106	-16.6	.149	14	.20	-129
2.0	.12	149	10.3	3.28	83	-15.3	.171	13	.23	-157
2.5	.18	150	9.4	2.95	66	-14.4	.190	12	.26	-176
3.0	.25	142	8.3	2.60	48	-13.7	.207	9	.29	167
3.5	.32	133	7.2	2.29	31	-13.2	.219	3	.30	152
4.0	.40	124	6.0	2.01	15	-13.0	.224	-1	.31	142
5.0	.53	106	3.7	1.53	-13	-12.8	.228	-11	.32	128

A model for this device is available in the DEVICE MODELS section.

### Typical Performance, $T_A = 25^\circ\text{C}$

(unless otherwise noted)

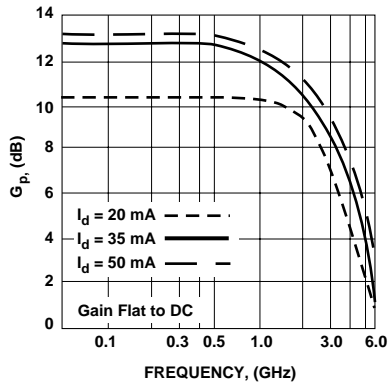

Figure 1. Typical Power Gain vs. Frequency,  $T_A = 25^\circ\text{C}$ .

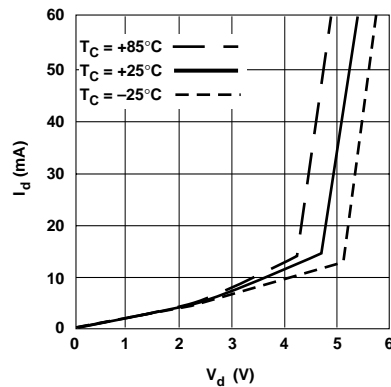

Figure 2. Device Current vs. Voltage.

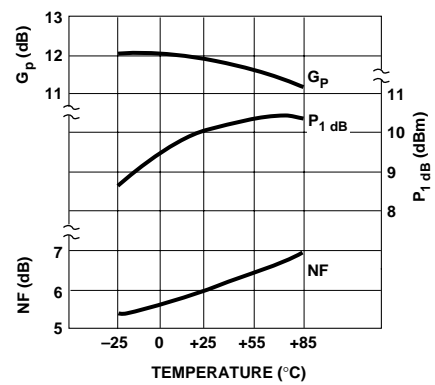

Figure 3. Output Power at 1 dB Gain Compression, NF and Power Gain vs. Case Temperature,  $f = 1.0 \text{ GHz}$ ,  $I_d = 35 \text{ mA}$ .

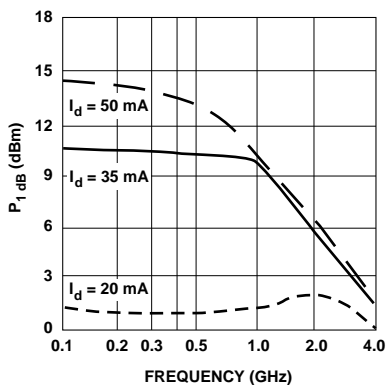

Figure 4. Output Power at 1 dB Gain Compression vs. Frequency.

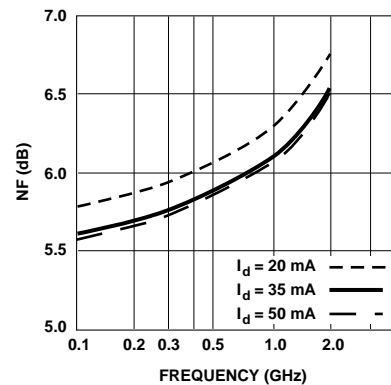

Figure 5. Noise Figure vs. Frequency.

## 86 Plastic Package Dimensions

