

Cascadable Silicon Bipolar MMIC Amplifier

Technical Data

MSA-0470

Features

- **Cascadable 50 Ω Gain Block**
- **3 dB Bandwidth:**
DC to 4.0 GHz
- **12.5 dBm Typical P_{1 dB} at
1.0 GHz**
- **8.5 dB Typical Gain at
1.0 GHz**
- **Unconditionally Stable
(k>1)**
- **Hermetic Gold-ceramic
Microstrip Package**

Description

The MSA-0470 is a high performance silicon bipolar Monolithic Microwave Integrated Circuit (MMIC) housed in a hermetic,

high reliability package. This MMIC is designed for use as a general purpose 50 Ω gain block. Typical applications include narrow and broad band IF and RF amplifiers in industrial and military applications.

The MSA-series is fabricated using HP's 10 GHz f_T , 25 GHz f_{MAX} silicon bipolar MMIC process which uses nitride self-alignment, ion implantation, and gold metallization to achieve excellent performance, uniformity and reliability. The use of an external bias resistor for temperature and current stability also allows bias flexibility.

70 mil Package

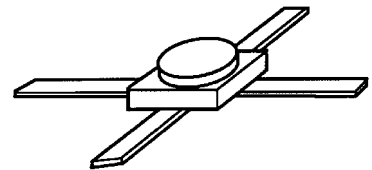

Typical Biasing Configuration

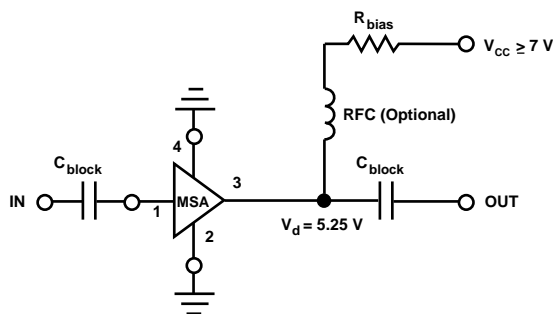

MSA-0470 Absolute Maximum Ratings

Parameter	Absolute Maximum ^[1]
Device Current	100 mA
Power Dissipation ^[2,3]	650 mW
RF Input Power	+13 dBm
Junction Temperature	200°C
Storage Temperature	-65 to 200°C

Thermal Resistance^[2,4]:

$$\theta_{jc} = 115^{\circ}\text{C/W}$$

Notes:

1. Permanent damage may occur if any of these limits are exceeded.
2. $T_{\text{CASE}} = 25^{\circ}\text{C}$.
3. Derate at 8.7 mW/°C for $T_{\text{C}} > 125^{\circ}\text{C}$.
4. The small spot size of this technique results in a higher, though more accurate determination of θ_{jc} than do alternate methods. See MEASUREMENTS section "Thermal Resistance" for more information.

Electrical Specifications^[1], $T_{\text{A}} = 25^{\circ}\text{C}$

Symbol	Parameters and Test Conditions: $I_{\text{d}} = 50 \text{ mA}$, $Z_{\text{O}} = 50 \Omega$	Units	Min.	Typ.	Max.
G_{P}	Power Gain ($ S_{21} ^2$) $f = 0.1 \text{ GHz}$	dB	7.5	8.5	9.5
ΔG_{P}	Gain Flatness $f = 0.1 \text{ to } 2.5 \text{ GHz}$	dB		± 0.6	± 1.0
$f_{3 \text{ dB}}$	3 dB Bandwidth	GHz		4.0	
VSWR	Input VSWR $f = 0.1 \text{ to } 2.5 \text{ GHz}$			1.7:1	
	Output VSWR $f = 0.1 \text{ to } 2.5 \text{ GHz}$			2.0:1	
NF	50 Ω Noise Figure $f = 1.0 \text{ GHz}$	dB		6.5	
$P_{1 \text{ dB}}$	Output Power at 1 dB Gain Compression $f = 1.0 \text{ GHz}$	dBm		12.5	
IP_3	Third Order Intercept Point $f = 1.0 \text{ GHz}$	dBm		25.5	
t_{D}	Group Delay $f = 1.0 \text{ GHz}$	psec		125	
V_{d}	Device Voltage	V	4.75	5.25	5.75
dV/dT	Device Voltage Temperature Coefficient	mV/°C		-8.0	

Note:

1. The recommended operating current range for this device is 30 to 70 mA. Typical performance as a function of current is on the following page.

MSA-0470 Typical Scattering Parameters ($Z_0 = 50 \Omega$, $T_A = 25^\circ\text{C}$, $I_d = 50 \text{ mA}$)

Freq. GHz	S_{11}		S_{21}			S_{12}			S_{22}	
	Mag	Ang	dB	Mag	Ang	dB	Mag	Ang	Mag	Ang
0.1	.18	179	8.5	2.67	176	-16.4	.151	1	.10	-14
0.2	.18	179	8.5	2.67	172	-16.4	.151	2	.10	-30
0.4	.18	179	8.5	2.67	163	-16.4	.152	3	.13	-50
0.6	.17	-179	8.5	2.65	155	-16.2	.155	5	.16	-67
0.8	.16	-176	8.4	2.64	147	-16.1	.158	8	.19	-79
1.0	.16	-174	8.3	2.61	138	-15.9	.161	6	.22	-90
1.5	.16	-166	8.2	2.56	117	-15.5	.169	9	.29	-111
2.0	.21	-163	7.8	2.46	97	-14.6	.186	9	.33	-131
2.5	.26	-162	7.3	2.33	83	-13.8	.204	12	.36	-142
3.0	.32	-170	6.5	2.12	65	-13.5	.212	10	.40	-156
3.5	.37	-177	5.7	1.93	38	-13.2	.220	7	.40	-164
4.0	.40	175	4.7	1.73	33	-12.6	.234	3	.40	-170
4.5	.41	166	3.9	1.57	20	-12.4	.239	-1	.39	-173
5.0	.42	155	3.1	1.44	7	-11.9	.255	-6	.37	-176

A model for this device is available in the DEVICE MODELS section.

Typical Performance, $T_A = 25^\circ\text{C}$ (unless otherwise noted)

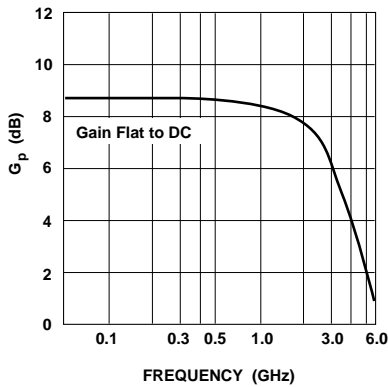

Figure 1. Typical Power Gain vs. Frequency, $T_A = 25^\circ\text{C}$, $I_d = 50 \text{ mA}$.

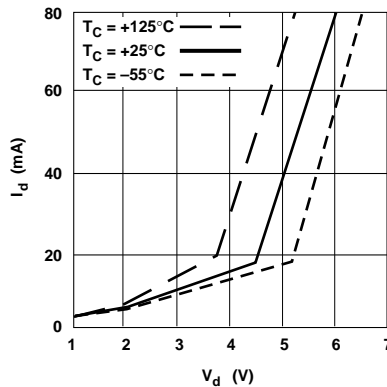

Figure 2. Device Current vs. Voltage.

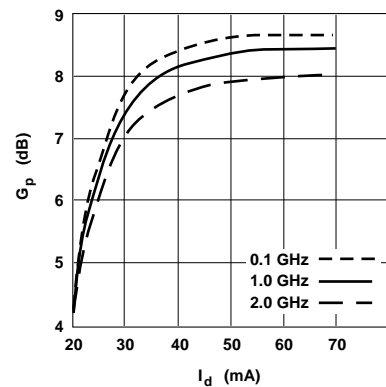

Figure 3. Power Gain vs. Current.

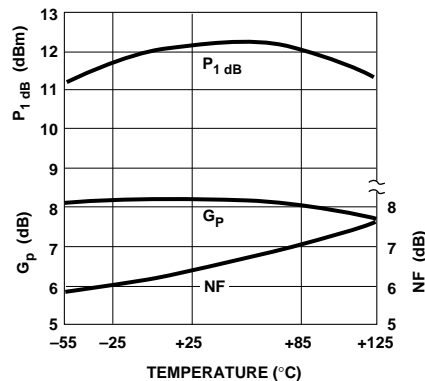

Figure 4. Output Power at 1 dB Gain Compression, NF and Power Gain vs. Case Temperature, $f = 1.0 \text{ GHz}$, $I_d = 50 \text{ mA}$.

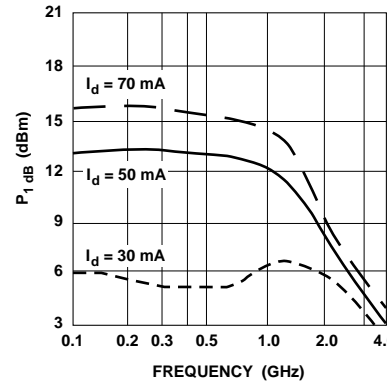

Figure 5. Output Power at 1 dB Gain Compression vs. Frequency.

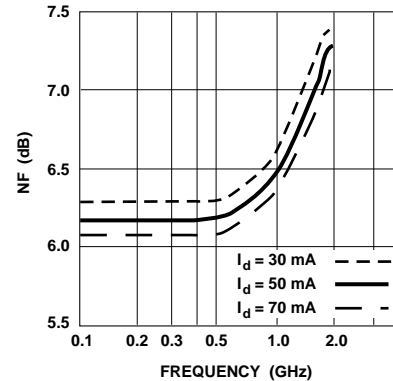
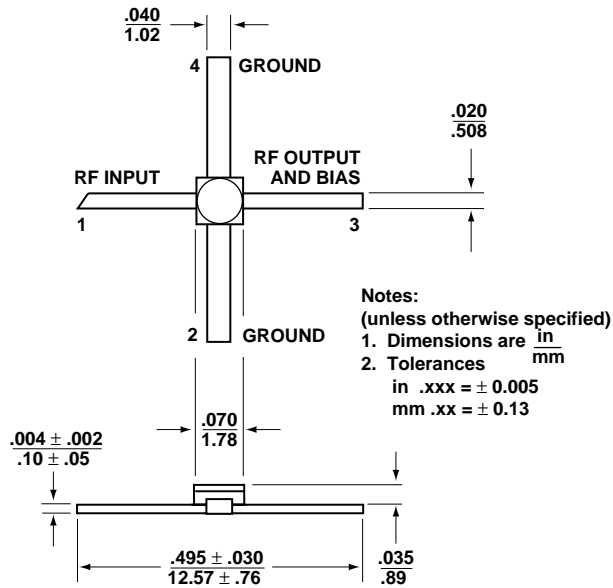

Figure 6. Noise Figure vs. Frequency.

70 mil Package Dimensions



www.hp.com/go/rf

For technical assistance or the location of your nearest Hewlett-Packard sales office, distributor or representative call:

Americas/Canada: 1-800-235-0312 or 408-654-8675

Far East/Australasia: Call your local HP sales office.

Japan: (81 3) 3335-8152

Europe: Call your local HP sales office.

Data subject to change.
Copyright © 1998 Hewlett-Packard Co.

Obsoletes 5965-9576E
Printed in U.S.A. 5966-4952E (5/98)